

20X

Tacking Machine-Touching Panel-E

2018-08



3006049

# Contents

1 General Information.....	6
1.1 General.....	6
1.2 Technical Parameters.....	6
1.3 Matters for Safe Using.....	7
1.4 The Preventions on Usage.....	9
1.5 Standardization.....	10
1.6 Operation Method.....	11
2 Operating Instruction.....	12
2.1 Common Buttons.....	12
2.2 Basic Operation.....	13
2.3 Operation of Normal Pattern.....	14
2.4 Pattern Registration.....	18
2.5 Pattern Naming.....	19
2.6 Winding.....	19
2.7 Pattern Selection.....	21
2.8 Sewing Data Setting.....	23
2.9 P Pattern Registration.....	25
2.10 Trial Sewing.....	26
2.11 Counter Operation.....	27
2.12 Emergency Stop.....	28
2.13 Setting of Thread Tension at Single Stitch.....	30
3 Operations on Prompt (P) Pattern.....	32
3.1 P Pattern Data Input.....	32
3.2 P Pattern Edition.....	34
3.3 P Pattern Copy.....	35
3.4 P Pattern Selection.....	36
3.5 P Pattern Sewing.....	38
4 Operations on Combination (C) Pattern.....	40
4.1 C Pattern Data Input.....	40

---

4.2 C Pattern Edition.....	41
4.3 C Pattern Selection.....	43
4.4 C Pattern Sewing.....	44
5 Pattern Edition.....	47
5.1 Have Access to Pattern Edition Mode.....	47
5.2 Pattern Edition.....	51
5.3 Quit Pattern Edition Mode .....	57
6 Information Functions.....	58
6.1 Maintenance & Repair Information .....	58
6.2 Input Time for Maintenance & Repair .....	59
6.3 How to Release Alarm .....	62
6.4 Production Control.....	62
6.4.1 Via Information Interface.....	62
6.4.2 Via Sewing Interface.....	64
6.4.3 Setting on Production Control.....	65
6.5 Display Threading Figure.....	68
6.6 Alarm Record.....	69
6.7 Running Record .....	71
6.8 Setting of Periodical Password.....	71
7 Communication Functions .....	79
7.1 About the Available Data .....	79
7.2 Operations .....	80
7.3 Pattern Transfer .....	80
7.4 Parameter Transfer .....	84
7.5 Software Update.....	86
8 Mode & Parameter Setting.....	88
8.1 List of Function Keys.....	89
8.2 Level 1 Parameters Setting.....	90
8.3 Level 2 Parameters Setting.....	97
8.4 Counter Setting .....	102
8.4.1 Functions.....	103

8. 5 Change Sewing Mode .....	104
8. 6 Have Access to Pattern Edition .....	105
8. 7 Set Pattern Lock .....	105
8. 8 Initialization .....	106
8. 9 Software Version Inquiry .....	108
8. 10 Test Mode.....	109
8. 11 Keyboard Lock.....	117
8. 12 Parameter Back-up .....	119
8.13 Button-stitching Function Setting .....	120
8.14 Pattern Edition Parameter Setting .....	123
9 Controller System Principle .....	124
9.1 Structure of Control System.....	124
9.1.1 Installation Size of Control Box .....	124
9.1.2 Installation Size of Operation Box .....	125
9.1.3 The Control System Diagram.....	126
9.1.4 External Cable Connection of Control Box .....	错误！未定义书签。
9.2 List of Patterns in 1900A Controller .....	127
9.3 List of Patterns for Button-sewing in 1900B Controller .....	131
9.4 List of Patterns for Doubling Controller .....	132
9.5 List of Warning.....	136
9. 6 Hint List .....	139

---

20X

Tacking Machine-Touching Panel-E

2018-08



3006049

# 1 General Information

## 1.1 General

This computerized control system for sewing machine features the following advantages: 1) Adoption of the world leading AC servo control technology on main shaft motor provides high torque, good efficiency, stable speed and low noise; 2) Diversified design of control panel can meet the special requirement of users on attachment; 3) System adopts German style structure, which offers easy installation and maintenance to users; 4) The system control software can be updated via the remote communication, which is easy for user to improve the performance of machine.

## 1.2 Technical Parameters

No.	Model	
	Items	20X
1	Usage	Doubling & Tacking, Button Sewing
2	Sewing Range	X(Left/ Right) Direction 40mm × Y(Forward/Backward) Direction 30mm
3	Max Speed	Max 3000rpm (For Double Hook type, it is 2700rpm)
4	Min Sewing Unit	0.1mm
5	Cloth-feeding	Indirect Cloth-feeding (Pulse Motor Dual-shaft Drive)
6	Stroke of Needle Rod	41.2mm
7	Needle	DP ×5 #14 (DP×5 #11(F,M), (DP×17#21 Thick Fabric))
8	Presser-lifting Device	Pulse Motor
9	Presser Height	Standard 14mm, Max 17mm(at Reverse Lifting)
10	Standard Pattern Number	50/100
11	Thread-wiping Method	Interaction by lifting presser with pulse motor
12	Needle Thread Tension	Electronic Thread-holder
13	Hook	Semi-rotation standard hook or Semi-rotation double hook
14	Oiling Method	Rotation Part: Slight Oiling
15	Oil	Sewing machine oil

16	Lubricating Grease	Lubricating grease for sewing machine
17	Data Memory	U Disk
18	Scaling Function	Independent scaling 20% ~200% at X direction and Y direction respectively (1% for each step)
19	Scaling Method	Change Stitch form length and stitch interval
20	Sewing Speed	400-3000rpm(100rpm per step)
21	Patten Selection	By selecting the number of pattern (1-200)
22	Bottom Thread Counter	Up/Down Method (0~9999)
23	Motor	500W Small AC Servo Motor (Direct Drive Mode)
24	Size	263mm×153mm×212mm
25	Weight of Control Box	About 10 Kg
26	Power	600W
27	Working Temperature	0°C ~45°C
28	Working Humidity	35%~85% (No Dew)
29	Voltage Input	AC 220V ± 10%; 50/60Hz

※ At daily usage, please lower the max sewing speed according to the sewing condition.

※Effective standard for product:QCYXDK0004—2016 《Computerized Control System for Industrial Sewing Machine》.

### 1.3 Matters for Safe Using

#### ● Installation

- Control Box
  - ◆ Please install the control box according to the instruction
- Attachments
  - ◆ If other attachments are needed, please turn off the power and pull off the power plug.
- Power Cable
  - ◆ Do not press power cable with force or excessively twist power cable.
  - ◆ The power cables shall be fixed with a distance at 25mm away from the rotating component at least
  - ◆ Before powering the control box, user shall carefully check the voltage of power supply and position of power input on control box. If the power transformer is used, user should also check it before powering the machine. At this moment, the power switch of sewing machine must be set as “Off”.
- Grounding

- ◆ In order to avoid the noise disturbance and shock caused by electrical leakage, user should ground the grounding cable.
- Attachments
  - ◆ If the electrical attachments are needed, please connect them to the proper positions.
- Disassemble
  - ◆ When removing the control box, user should turn off the power and pull off the power plug.
  - ◆ At pulling off the power plug, user should hold the plug and remove it, instead of pulling the power cable only.
  - ◆ The control box contains the dangerous high voltage power. For opening the control box, please turn off the power and take away the plug from socket firstly, and then wait for at least 5 minutes before opening the control box.

## ● Maintenance, Inspection and Repair

- Only can the trained technicians perform the repair and maintenance of this machine.
- When replacing the needles and shuttles, user has to turn off the power.
- Please use the spare parts from the authorized manufacturers

## ● Others

- Do not touch the rotating or moving part of the machine, especially the needle and belt, when the machine is working. User should also keep his/her hair away from those moving parts, so as to avoid the danger.
- Do not drop the control device on the floor, nor insert ant stuff into the slot on the control box.
- Do not run the machine without the cover shells
- If this control device is damaged or unable to work normally, please ask the technicians to adjust or repair it. Do not run the machine when the problem is not solved
- Please do not change or modify the control device without authorization

## ● Abandonment

- Dispose it as common industrial trash.



## ● Warning and Danger

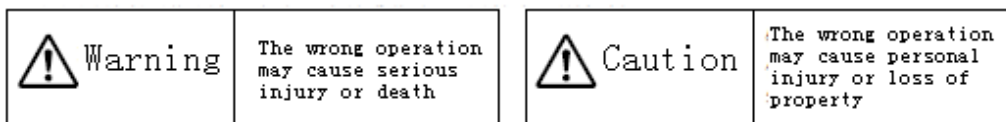

- The mistake operation may cause danger. For the serious level, please refer to the figure at below



- The meaning of the figure are shown at below:



	Please operate machine according to instruction
	Caution: High Temperature
	Never do this.

	Caution: High Voltage
	Grounding is a must

### 1.4 The Preventions on Usage

## Warning.

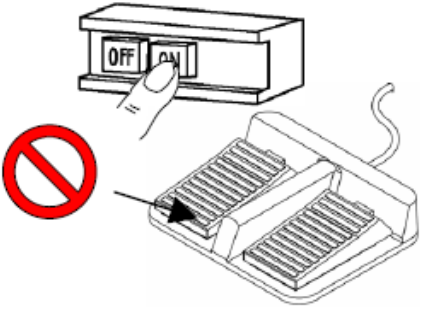
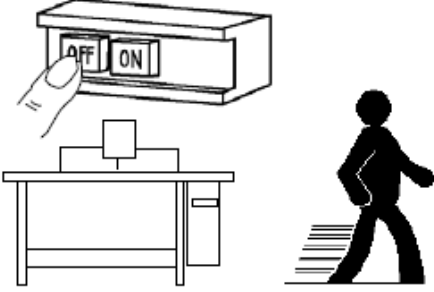
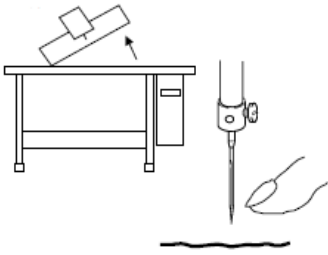
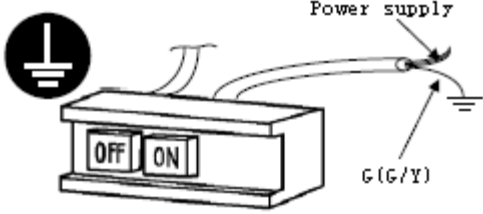
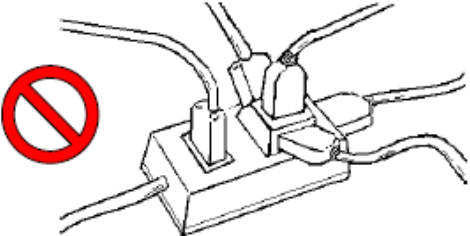
<p>1、 When you press [ON], leave the feet from pedal.</p> 	<p>2、 When you leave the machine, please turn it off.</p> 
<p>3、 If user needs tilt the head or replace the needle or thread the Needle thread, please turn off the power</p> 	<p>4、 Ground the machine with ground cable</p> 
<p>5、 Do not use the household terminal block to let machines to share one power supply</p> 	<p>6、 For opening the control box, please turn off the power and take away the plug from socket firstly, and then wait for at least 5 minutes before opening the control box</p>

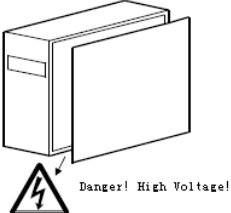
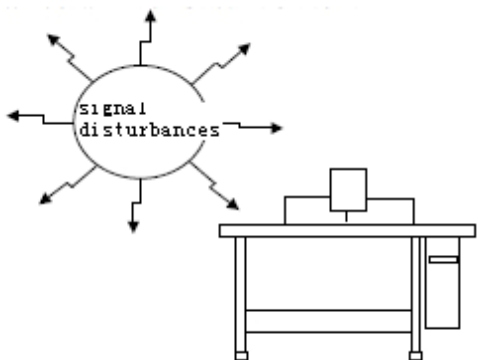
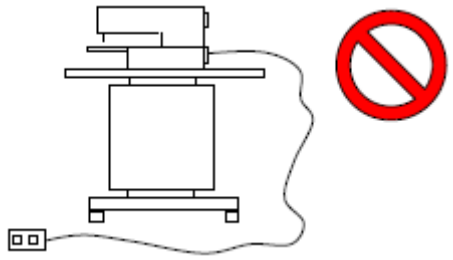
	
<p>7、 After replacing the motor, please set the installation angle of main motor according to this documents.</p>	
<p>8、 Please keep it away from the machine creating the high cyclic disturbance</p> 	<p>9、 If user needs the external signal socket to connect the attachments, the connecting wire shall be as short as possible. The long cable may cause the wrong operation. And the connection cable shall be the isolated cable</p> 
<p>10、 If the fuse is burnt, please solve the problem before replacing a new one with same capacity</p>	

### 1.5 Standardization

The button using the common figure can be understood the users from different countries.

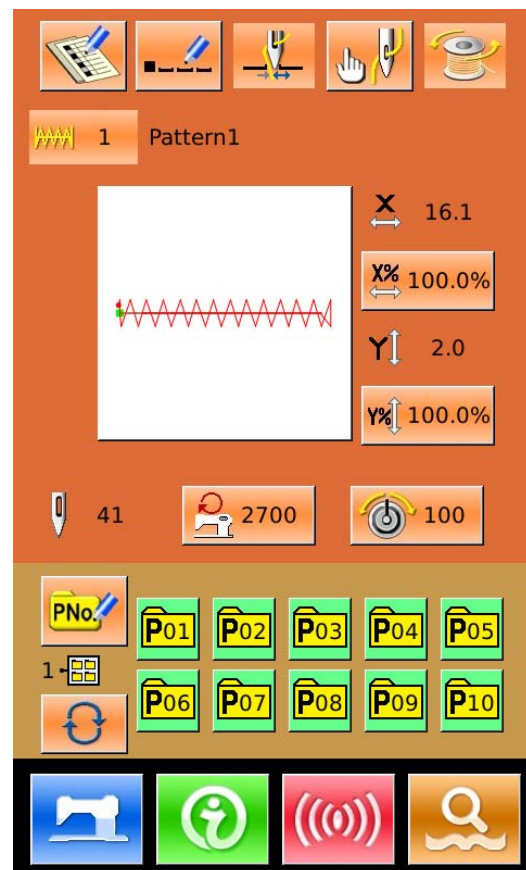

by

## 1.6 Operation Method

We use the advanced touching operation technique on the operation panel, whose friendly interface and simple operation will bring the big changes to users in their usage. Users can finish the relating operations by using their fingers or other object to touch the screen. **Never use sharp object to touch the screen, otherwise the touching panel will suffer the permanent damage.**

The function keys include Ready Key, Information Key, Mode Key and Communication Key. For the specific operation, please refer to the chapters at below:













**Never use sharp object to touch the screen, otherwise the touching panel will suffer the permanent damage**

## 2 Operating Instruction

### 2.1 Common Buttons

The buttons for the common operation in each interface are shown at below:

No.	Figure	Functions
1		ESC → Quit the current interface. At data change interface, it is for canceling the change of data.
2		Enter → Confirm the changed data.
3		Plus → Increase the value
4		Minus → Decrease the value
5		Reset → Release the Error
6		Number Input → Display the number keyboard and input the number.
7		READY Key → Shift between the data input interface and sewing interface
8		Information Key → Shift between the data input interface and information interface
9		Communication Key → Shift between the data input interface and communication interface
10		Mode Key → Shift between the data input interface and communication interface

## 2.2 Basic Operation

### ① Turn on the power

Turn on the power to display the data input interface.

### ② Select the wanted pattern No.

At current interface, the selected pattern No. will be

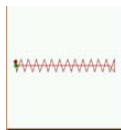

displayed. Press  to select pattern number.

For the operation of pattern selection, please refer to **【2.7 Pattern Selection】**.

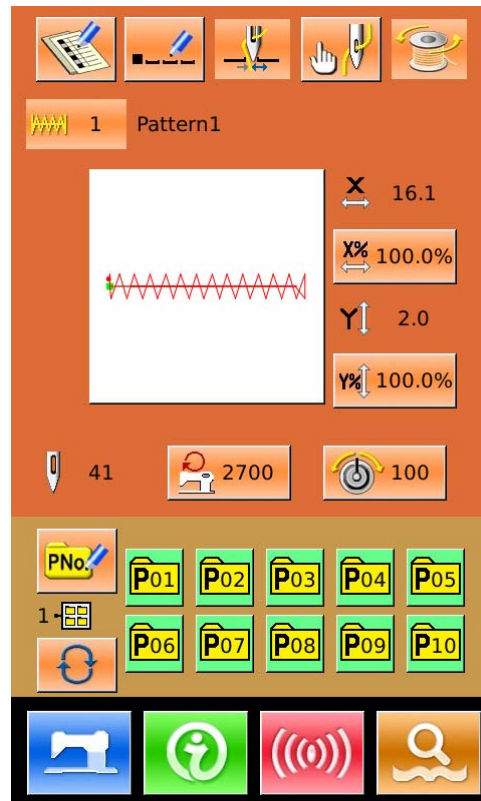

### ③ Set machine to Ready Sewing Status

Press READY key . The back-light of LCD displayer changes to blue color and the machine is ready for sewing.

### ④ Start Sewing

Set the sewing product to the presser position; operate the pedal to start the sewing machine, and sewing starts

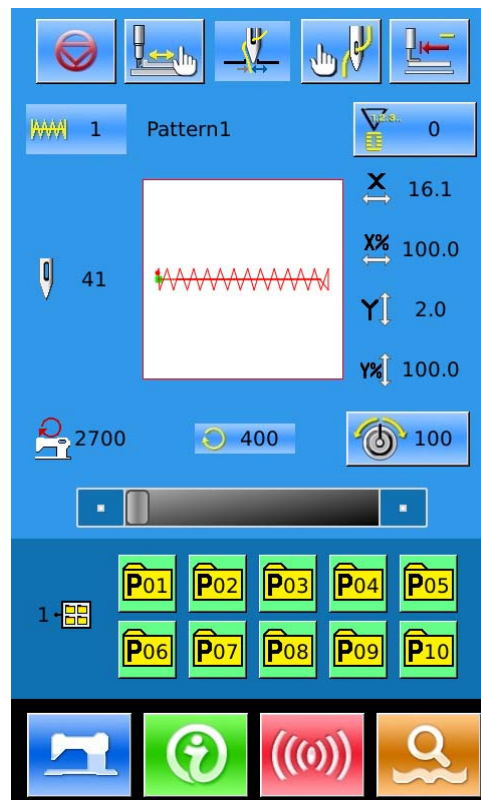

## 2.3 Operation of Normal Pattern

### (1) Sewing Data Input Interface

The data input interface is shown at right. For the detailed functions, please refer to the Function Key List

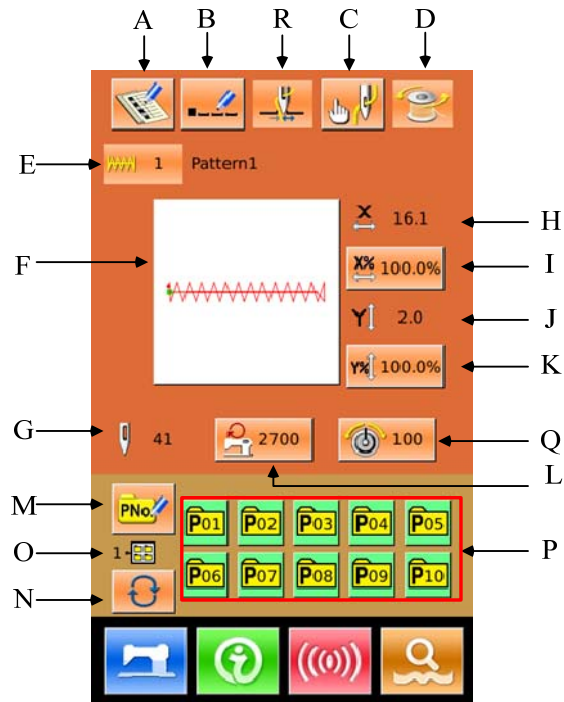

### Function Key List:

No.	Function	Content
A	Pattern Registration	At most, 999 normal patterns can be registered.
B	Pattern Naming	At most, 14 figures can be input.
R	Thread-catching (Displayed according to the actual condition of machine)	Activate the thread-catching function. It is affected by parameter U35.
C	Threading	Lower the presser to display the interface. For lifting the presser, please press "Presser Up" button.
D	Winding	Press  to start winding.
E	Pattern No. Display	Display the current pattern number
F	Sewing Pattern	The button will display the shape of the current pattern. Press it to enter

	Selection	the interface for selecting patterns
G	Pattern Stitch Number	Display stitch number of the current pattern
H	X Actual Size	Display the actual size of current pattern at X direction. Use parameter U64 to input the actual size, at this moment the X Actual Size button is displayed.
I	X Scale Rate	The button will display the X scale rate of the current pattern. Press it to enter the interface for setting. It is affected by parameters U64 & U88.
J	Y Actual Size	Display the actual size of current pattern at Y direction. Use parameter U64 to input the actual size, at this moment the Y Actual Size button is displayed.
K	Y Scale Rate	The button will display the Y scale rate of the current pattern. Press it to enter the interface for setting. It is affected by parameters U64 & U88.
L	Max Speed	Display the Max Speed. Press this button to set the speed
M	Prompt Pattern (P Pattern) Registration	It is used for P pattern registration. At most, 50 P patterns can be registered.
O	P Pattern File Folder Number	Display the file folder number of current P pattern
N	P Pattern File Folder Selection	Shift P pattern file folder number orderly.
P	P Pattern Selection	Display the registered P pattern. Press it to enter the interface for inputting P pattern data. This button is not displayed at initial status.
Q	Thread Tension Setting (this button is displayed according to the actual condition of machine)	Display the basic value of thread tension. Press button to set the value

**(2) Sewing Interface**

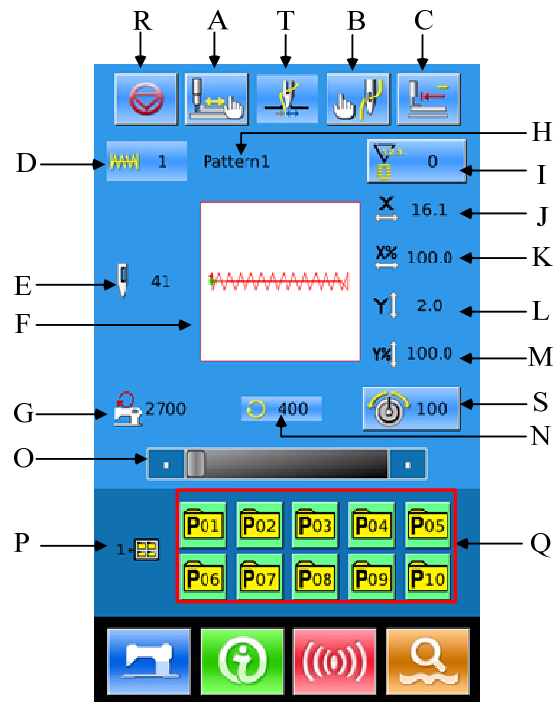

Press  to enter the Sewing Interface shown as the figure at right. For detailed functions please take the Function Key List for reference.



**Function Key List:**

No.	Function	Content
A	Trial Sewing	Press it to enter the trial sewing interface, where the pattern shape can be set.
T	Thread-catching (Displayed according to the actual condition of machine)	Activate the thread-catching function. It is affected by parameter U35.
B	Presser Down	Lower presser to display the presser down interface. For lifting the presser, please press the “Presser Up” Button.
C	Return to Origin	Press it to have presser return to the start sewing point and go up.
D	Pattern Number	Display the number of the current pattern
E	Pattern Stitch Number	Display the stitch number of the current pattern
F	Pattern Shape	Display the shape of the current pattern



G	Max Speed	Display the Max Speed
H	Pattern Name	Display the name of the current pattern.
I	Counter Setting	Press it to set the counter type and current counter value  : Sewing Counter  : No. of piece counter
J	X Actual Size	Display the X actual size of current pattern
K	X Scale Rate	Display the X scale rate of current pattern
L	Y Actual Size	Display the Y actual size of current pattern
M	Y Scale Rate	Display the Y scale rate of current pattern
N	Sewing Speed	Display the current sewing speed
O	Set Sewing Speed	Change the sewing speed
P	P Pattern File Folder Number	Display the number of the current P pattern file folder
Q	P Pattern Selection	Display the registered P pattern. Press it to enter the interface for sewing P pattern.  This button is not displayed at initial status.
R	Pause	Press it to stop the machine.  It is affected by parameter U31. When this button is selected, the interface will only display this button
S	Thread Tension Setting (this button is displayed according to the actual condition of machine)	Display the basic value of thread tension. Press button to set the value

## 2.4 Pattern Registration

999 normal patterns can be registered for the

most. press  to enter the interface of Pattern Registration (shown as the right figure):

### ① Input Pattern No.

Input the pattern No. via keyboard. If the pattern number is already existed in the system, the look and relevant information of the registered pattern will be shown on

the upper interface. by pressing ,

 user can search the unregistered number.

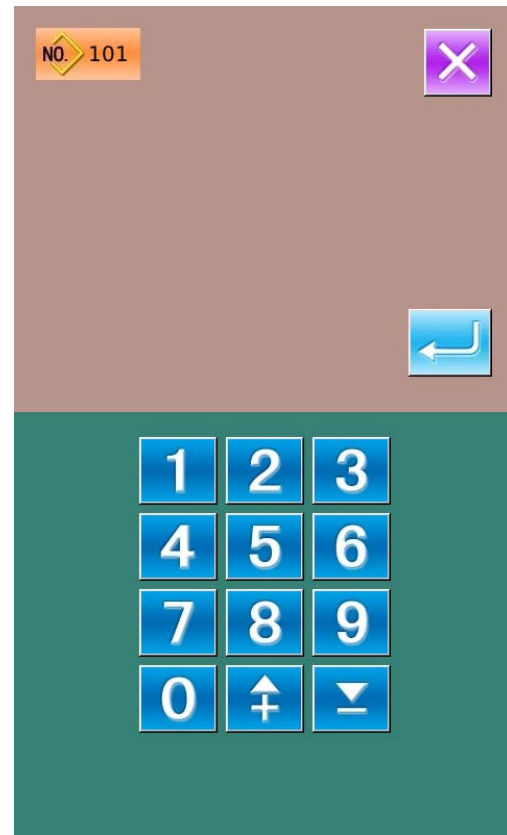

### ② New Pattern Registration

After confirming the pattern number, user can press . The displayed pattern data will be copied to the newly registered pattern. After the operations, the system will return to the interface for inputting data of the newly registered pattern

If user inputs the existed pattern number, the system will ask user whether to replace the saved pattern.

**Note: the Basic pattern cannot be replaced**

## 2.5 Pattern Naming

Press  to enter the interface for naming pattern (as shown in the right figure), 14 figures can be inputted at the most.

 : Icon Right-moving

 : Icon Left-moving

 : Caps Locks

 : Eraser

Select the figure wanted, press  to end the operation of naming the pattern.

The position of figure can be determined by moving the icon, the Eraser is used to delete the figure

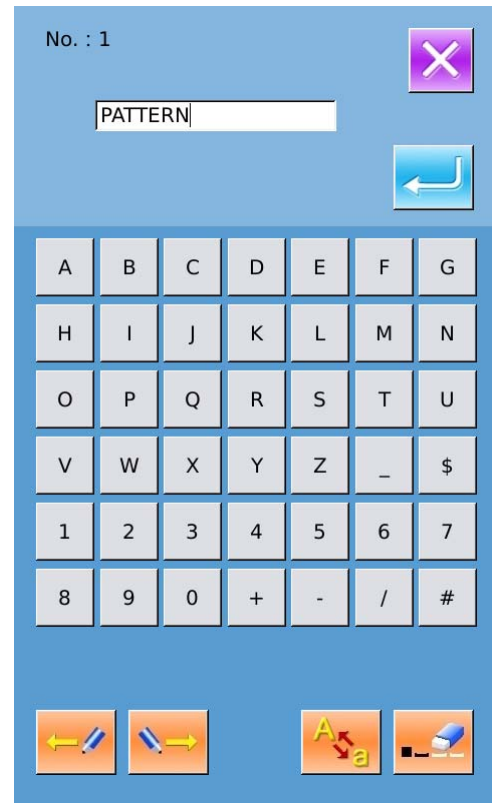

## 2.6 Winding

### ①Install the shuttle core

Fit the shuttle core fully onto the winder shaft. (as shown in the figure in right)

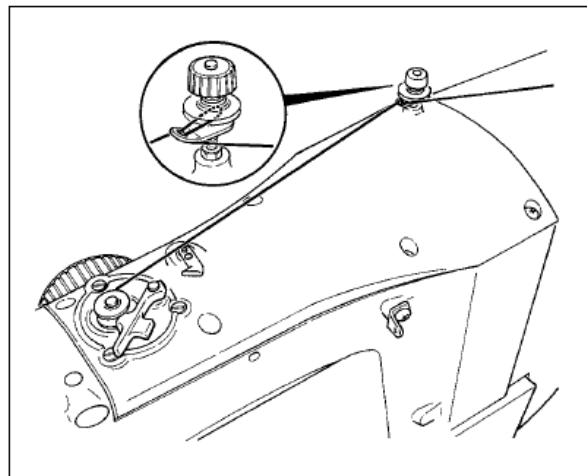

## ② Display the bottom thread winding screen

Press  in the data input interface, and then the winding interface will be displayed (as shown in the right figure)

## ③ Start Winding

Step the start pedal, and then the sewing machine runs and starts winding bottom thread.

## ④ Stop the sewing machine

Press STOP button  to stop the sewing machine. The system will return to the normal mode. By the way, in the bottom-thread winding mode, stepping the start pedal will stop the machine at this mode. Step the pedal again to resume winding. This function can be used at winding several shuttle cores.

Note: After user turns on the power, or changes to main controller input, the system will not perform the winding action. Please set the pattern and press the  to display the sewing interface.

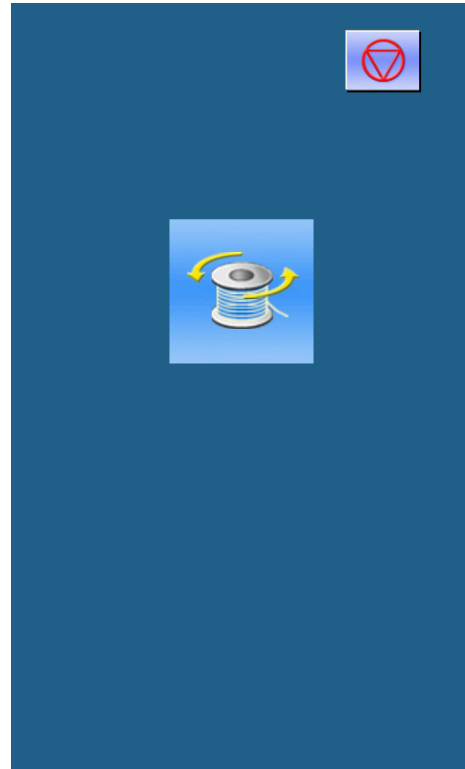

## 2.7 Pattern Selection

### ①Enter Pattern Selection Interface

In the data input interface (as shown in right), click Sewing Shape (A) to enter the interface for selecting patterns.

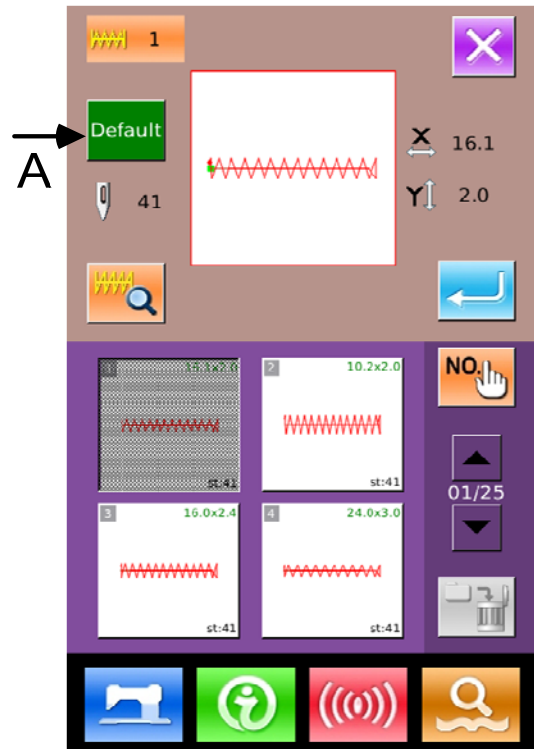
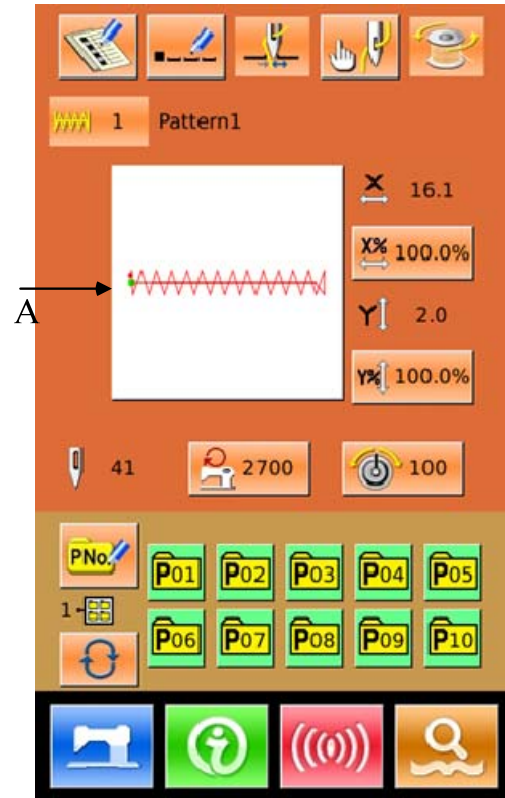

The upper area of the pattern selection interface is the sewing shape of the current pattern. Below that it is the number of the registered pattern.

 : Preview the pattern

 : Input the number to inquire pattern

: Delete the pattern

Click button A to shift between the basic patterns and user patterns, if the system has the normal patterns

**②Pattern Selection**

If the patterns are the basic patterns, 4 pattern numbers can be displayed in one page; for the user patterns, 20 pattern numbers can be displayed in one page. For the basic pattern, at each pattern number, the system will also display the shape and x/y range of the pattern. For the user patterns, only the pattern number will be displayed.

Select the registered pattern number. Then the system will display the content of that pattern in upper area. At this moment, press  to finish the selection.

**③Pattern Inquiry**

Press  to activate the interface of Pattern Inquiry, input the number of pattern via the number keys.

**④Pattern Deletion**

Select the registered pattern and then press , the pattern will be deleted. However, the patterns registered to P pattern can't be deleted.

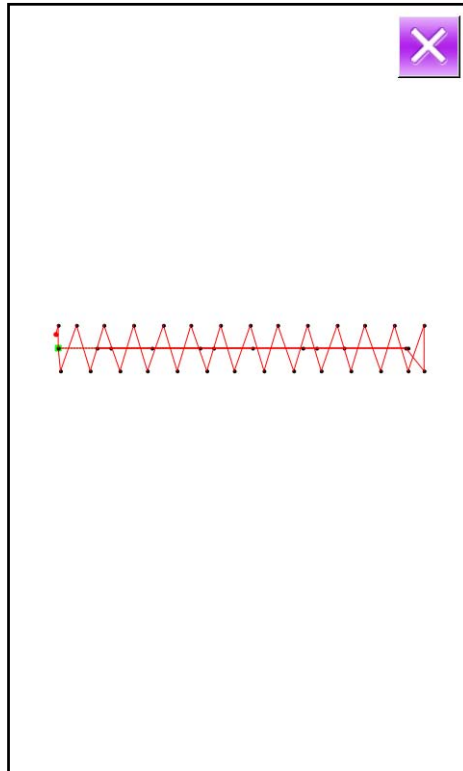
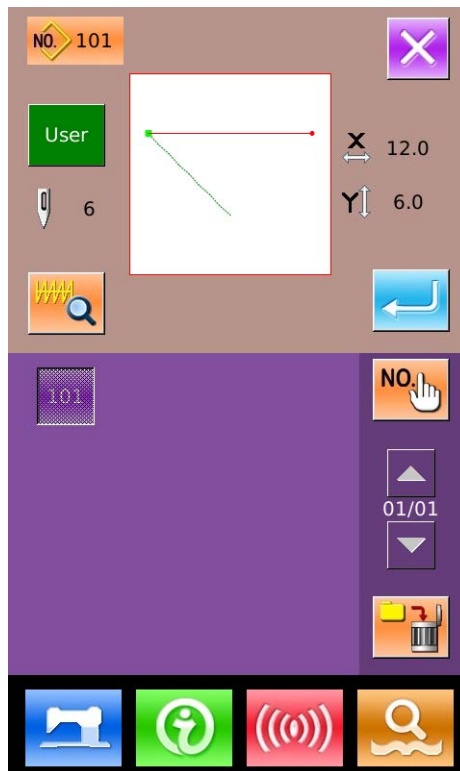

**Note: Patterns are divided into basic pattern and normal pattern. The basic patterns are the default patterns, which can't be deleted. The normal patterns are the patterns made, copied or input by user, which can be deleted or modified.**

**⑤Pattern Preview**

Press  to preview the current pattern in full screen (White Background).

**2.8 Sewing Data Setting**

**①Enter Interface for Setting the Sewing Data**

In data input interface, pressing button A, B or C can enter the scale rate setting interface and speed limitation interface respectively.

	Item	Input Range	Default Value
A	X Scale Rate	1.0~400.0%	100.0%
B	Y Scale Rate	1.0~400.0%	100.0%
C	Max Speed	400~2700rpm (Different among different models)	2700rpm

Note 1: Parameter U64 can shift between the setting of scale rate and the setting of actual size.

Note 2: The range and the default value of Max speed are affected by the parameter U01.

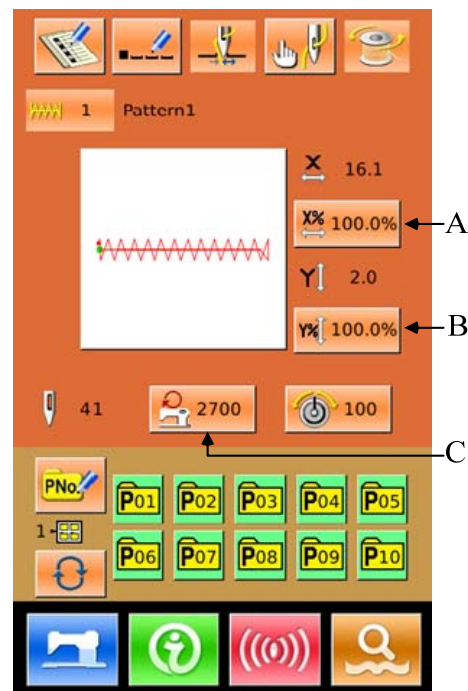

②Set Scale Rate

The right figure is the interface for setting the scale rate. The upper part is for setting X scale rate, while the lower part is for setting the Y scale rate.

A: X Actual Size

B: X Scale Rate

C: Y Actual Size

D: Y Scale Rate

Use **0** ~ **9** and number keyboard or **↑** & **↓** to input the value. The input value will be inserted to the first place of the figure. The number input at before will be moved forwards. Press **↵** to finish the operation and return to data input interface.。

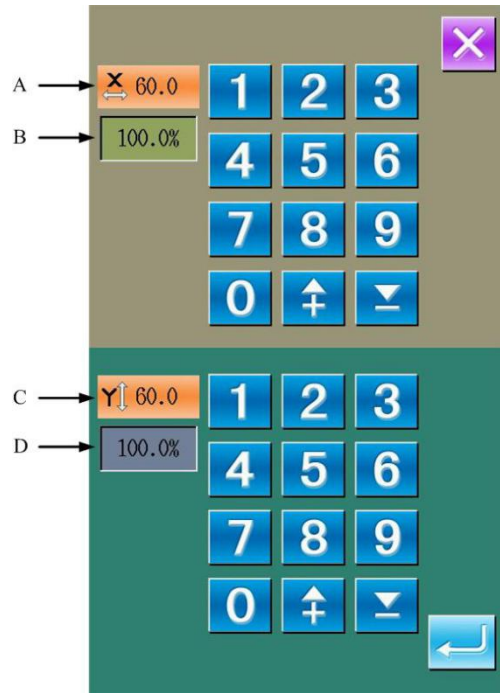

③Set Max Speed

The operation is same to that in above.

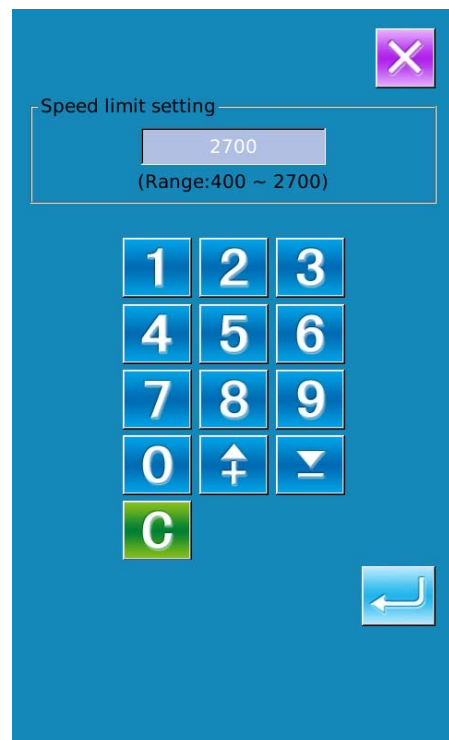







## 2.9 P Pattern Registration

### ①Enter P Pattern Registration Interface

In data input interface, press  to enter the interface of P Pattern Registration (shown as the right figure)

### ②Input P Pattern Number

Use  ~  and number keyboard or  &  to input the number for registration. If the input number has been registered in the system before, the interface will display the shape and relating data of that registered pattern. In this situation, the new pattern can not be registered with this number

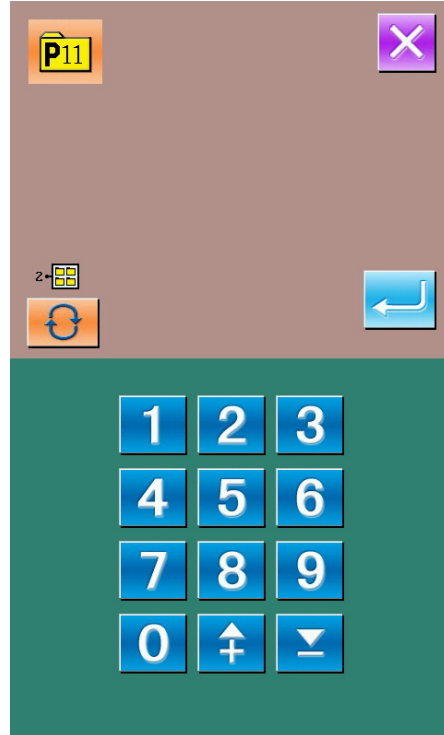

### ③Select File Folder Number

P pattern number can be registered into 5 file folders, and each folder can contain 10 P patterns at most.

Press  to select folder in order.

### ④Confirm Pattern Number

Press  to finish the Registration of P Pattern and return to the input interface of P Pattern Data

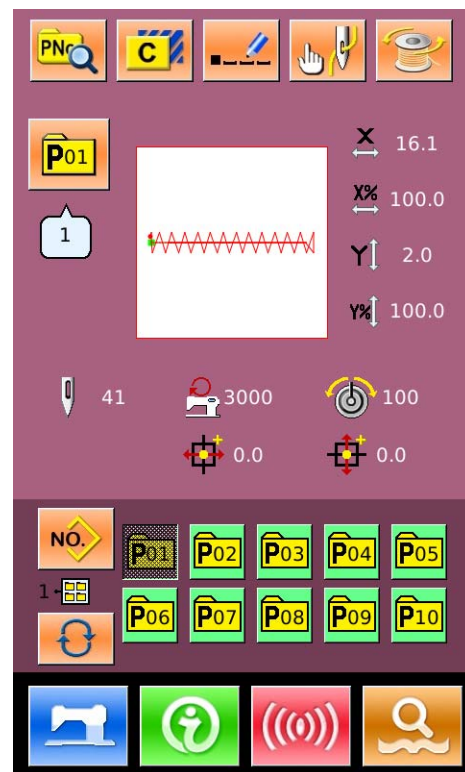





## 2.10 Trial Sewing

### ① Display the interface of sewing

At data input interface, press , the background of screen will change to blue, and the system enters the interface for sewing



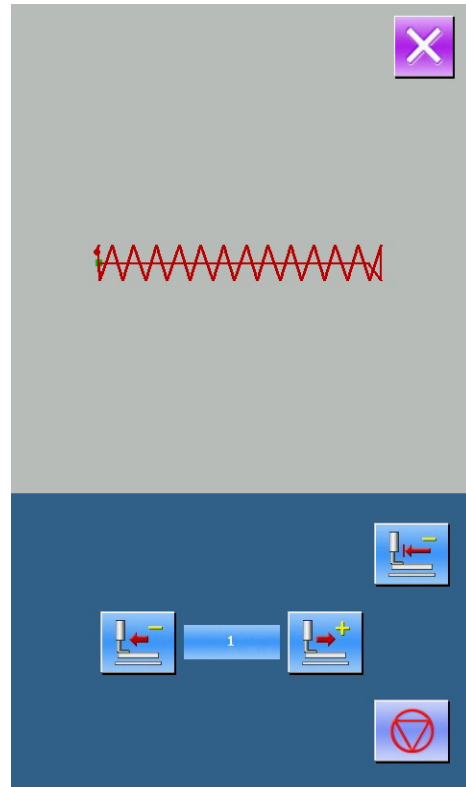

### ② Display of Trial Sewing

In the sewing interface. Press  to enter the trial sewing interface (As Shown at Right):



-  : Return to Origin
-  : Return
-  : Forward
-  : Stop



### ③ Start Trial Sewing



Step the pedal to lower the presser. Use  and  to confirm the shape. After user holds that button for a while and then release it, the presser will still keep moving. At this moment, please press  to stop it. Press  to have needle return to origin. And the system will return to the sewing interface.

### ④ End Trial Sewing

Press  to quit the trial sewing interface and return to sewing interface. When the pattern is not at the start position or end position, user can carry out sewing in the middle by stepping the pedal. For quit, please press  and turn off the activated interface. Then the sewing interface will displayed and the system returns to the sewing start position.

## 2.11 Counter Operation

### ① Display the counter interface

In the sewing interface, press  (  ), the interface of counter setting comes out.



: Sewing Counter



: No. of Pieces Counter

### ② Selection and Setting of Counter

The user can set the type of counter by choosing



and

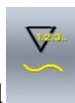

, and set the value of counter

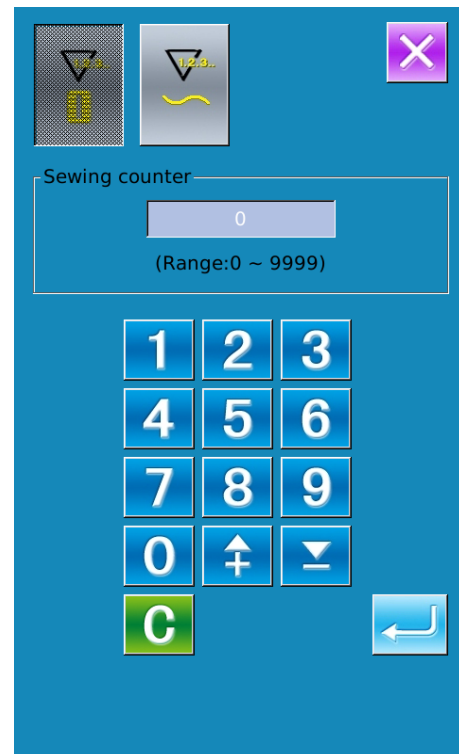

## 2.12 Emergency Stop

By setting parameter U31 to select pause method:

User can select among Invalidity, Panel and EXT to set the pause method.

When the pause button is pressed, the interface

will display the .

### ①Release the Error

Press Pause button at sewing to stop sewing machine. At this moment, the error interface is displayed, which hints user the pause key is

pressed. At this moment, press  to release the error.

### ②Trimming

Press  to cut thread and enter the procedure setting interface.

**Note:** When the Parameter U97 is set at Auto Trim at Pause, the system will enter procedure setting directly.

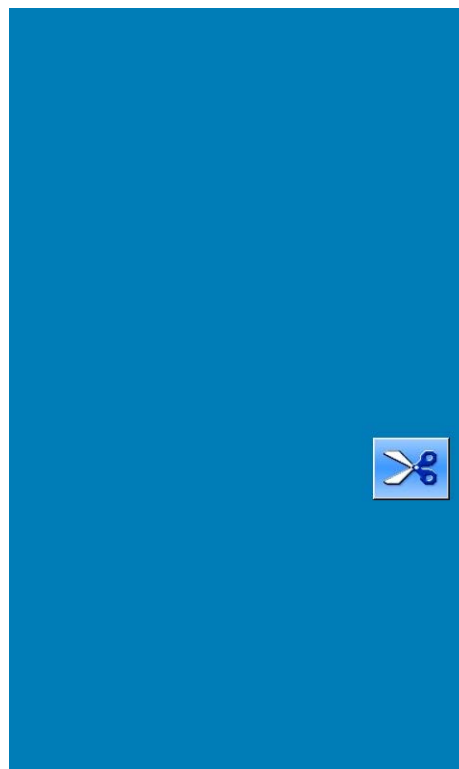
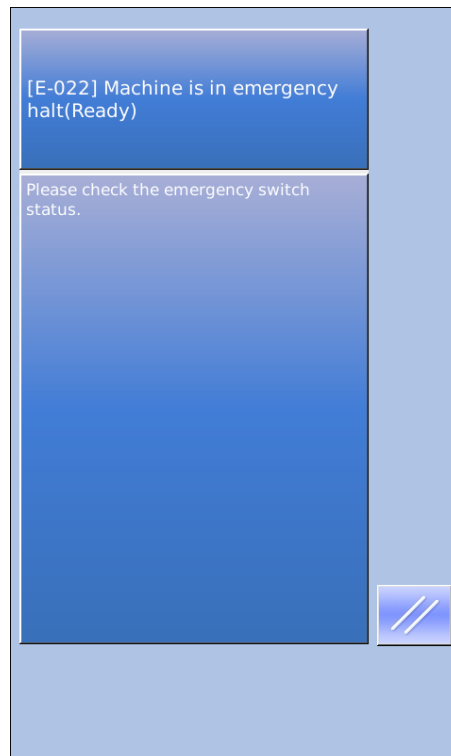



## ② Set procedure and adjust the presser to re-sewing position

Press  to enter procedure setting interface.

 : Backward feeding

 : Forward feeding

 : Return to Origin

Press  or  to move presser to the re-sewing position

## ③ Restart sewing

Step pedal to restart sewing

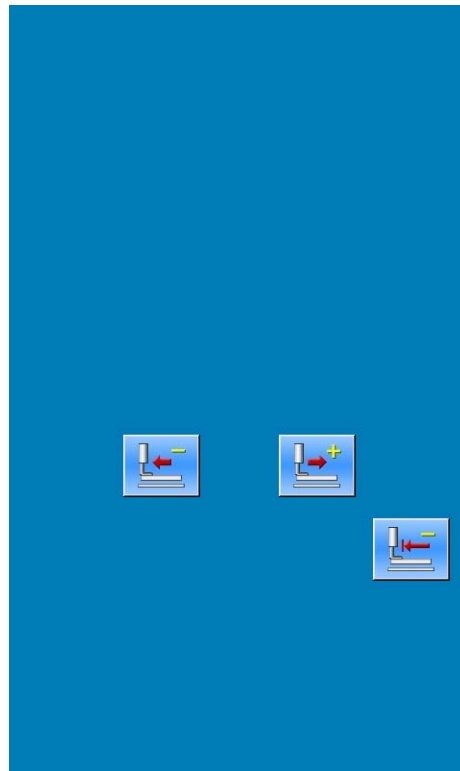

### 2.13 Setting of Thread Tension at Single Stitch

①Enter the interface for setting single stitch thread tension



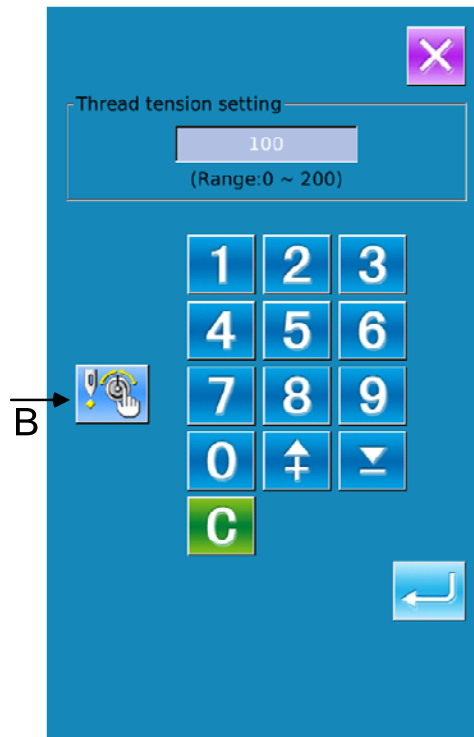
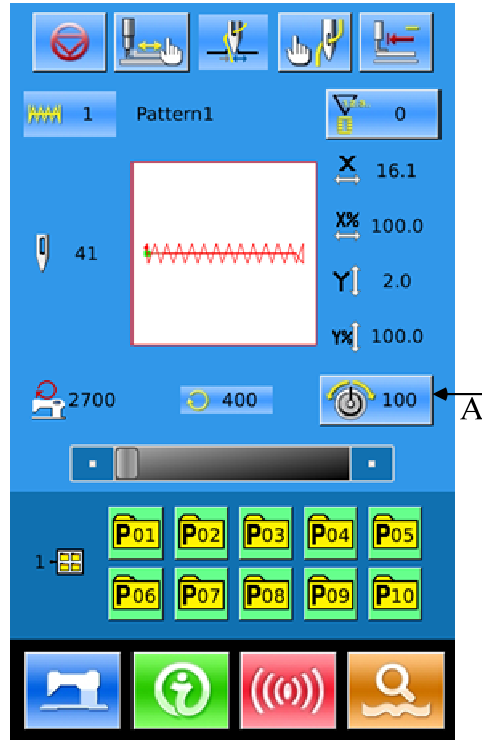

In the running interface (as shown in right), click button A to enter the interface for setting the thread tension.



In the thread tension setting interface (as shown in right), click single stitch thread tension button (B) to enter the interface for setting single stitch thread tension.

② **Setting of Single Stitch Thread Tension**

Click  to enter the thread tension setting interface. The setting method is same to that in 2.5.

In the status of lowering the outer presser, use  or  to go forward or retreat for one stitch. Use  or  to move the needle entry point with thread tension order forwardly or backwardly. For stopping the machine, please press .

Press  to return to origin.

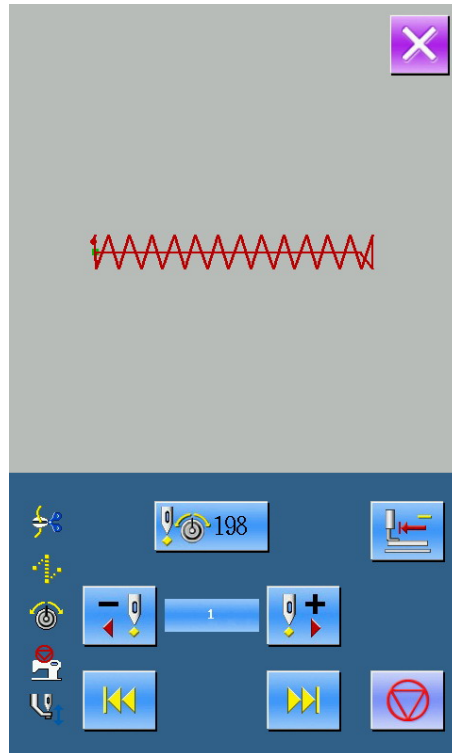

### 3 Operations on Prompt (P) Pattern

#### 3.1 P Pattern Data Input

The Prompt pattern is called P Pattern for short, which contains a normal pattern and its relating sewing parameters, like X scale rate, Y scale rate, speed limitation and so on. If selecting a P pattern, user will get rid of the trouble for setting the parameters of the pattern at each time sewing

In the right picture, is shown the P Pattern Data Input Interface.

50 P patterns can be registered at most.

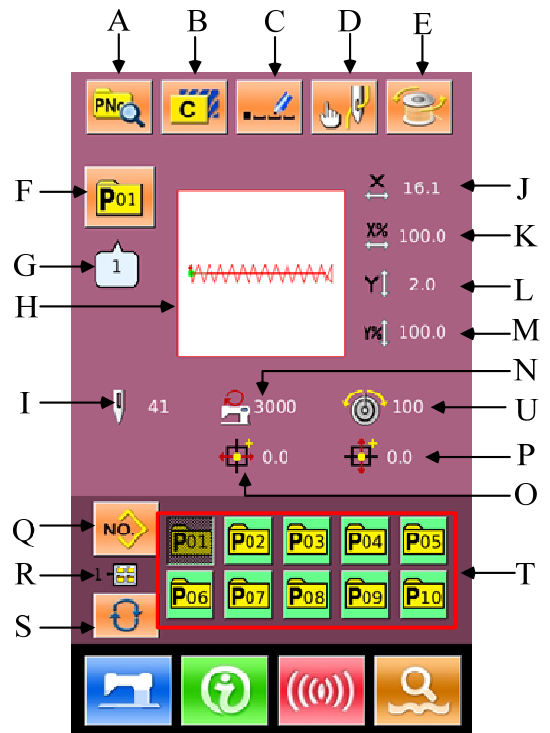

**List of Function Keys:**

No.	Functions	Content
A	P Pattern Edition	Edit the content of P pattern
B	P Pattern Copy	Copy the content of existing P pattern to an empty pattern number.
C	Pattern Naming	14 figures can be inputted at most.
D	Threading	Presser it to lower the presser.
E	Winding	Wind the thread with a press on 
F	P Pattern Number Display	Display the number of the selected pattern.
G	Sewing Shape Number Display	Display the number of the normal pattern quoted in the existing P pattern.



No.	Functions	Content
H	Sewing Shape Selection	Display the sewing shape of the current pattern
I	Pattern Stitch Number Display	Display the stitch number of the currently selected pattern.
J	X Actual Size Display	Display the X actual size of current pattern
K	X Scale Rate Setting	Display the X scale rate of current pattern
L	Y Actual Size Display	Display the Y actual size of current pattern
M	Y Scale Rate Setting	Display the Y scale rate of current pattern
N	Max Speed Limitation	Display the Max Speed
O	X Travel Amount Display	Display the X travel amount of the currently selected pattern
P	Y Travel Amount Display	Display the Y travel amount of the currently selected pattern
Q	Return to Normal Pattern Data Input	Return to the interface for inputting normal pattern data
R	P Pattern File Folder Display	Display the file folder number of the current P pattern
S	P Pattern File Folder Selection	Shift the file folder number of P pattern in sequence.
T	P Pattern Selection	Display the registered P pattern
U	Thread Tension Value	Display the basic value of thread tension of this pattern

### 3.2 P Pattern Edition

#### ①Have Access to P Pattern Edition Interface

Press  to have access to P Pattern Edition Interface (as shown at the right picture)

#### ②Change the Item Data

Select the item for changing and set the value.

	Item	Range	Default Value
A	Sewing Shape		
B	File Folder Number	1~5	
C	Max Speed Limitation	400~3000rpm	3000rpm
D	X Travel Amount	-30.0~30.0mm	0
E	X Scale Rate	1.0~400.0%	100.0%
F	Y Scale Rate	1.0~400.0%	100.0%
G	Y Travel Amount	-30.0~30.0mm	0
H	Thread Tension	0~200	100

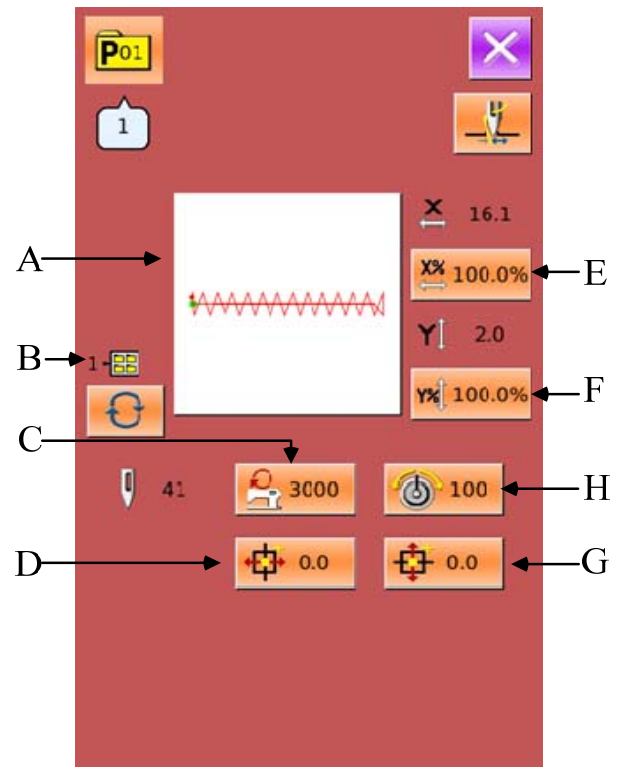

### ③ Confirm the Change of Data

Take the edition of “X Travel Amount” as example:

With **0** ~ **9** and keyboard or **↑** / **↓**, user

can input the value. Press **↩** to finish the operation.

**+**: The Positive Figure;

**-**: The Minus Figure.

### ④ Quit the Edition

Press **✕** to close P Pattern Edition Interface and the system will return to the Interface for Inputting Sewing Data.

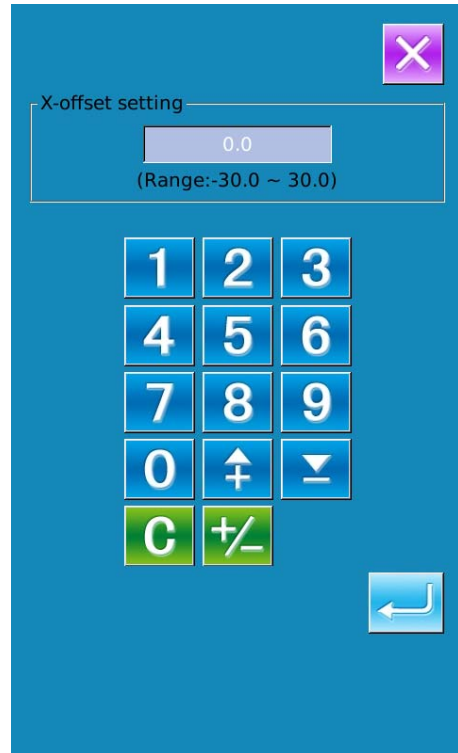

## 3.3 P Pattern Copy

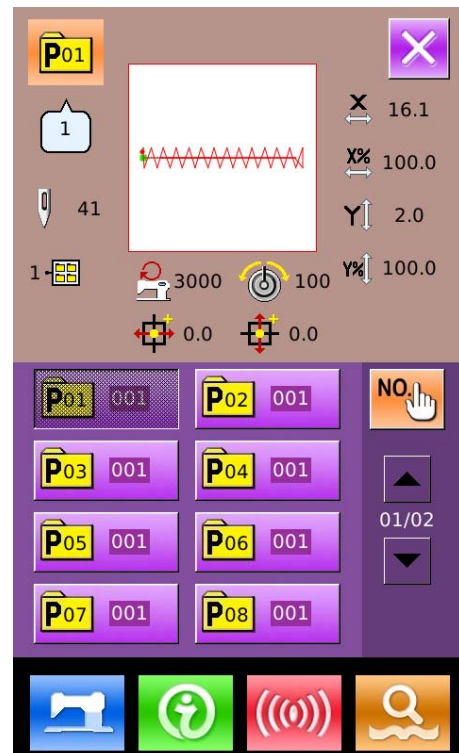

### ① Select a Pattern to Be Copied

Press **C** to have access to P Pattern Copy Interface (as shown at right picture). Select the number of the pattern that needs copying among the registered ones, and then press **NO**.



**②Input newly Registered Pattern Number**

The Pattern to be copied is displayed at the upper side of the interface. By using number keys, user can select the unregistered pattern number. The registered pattern number is unable to be registered again.

When pressing , user can select the file folder for saving. Press  to finish the operations for copying the pattern, and the system will return to the Interface for Copying P Pattern

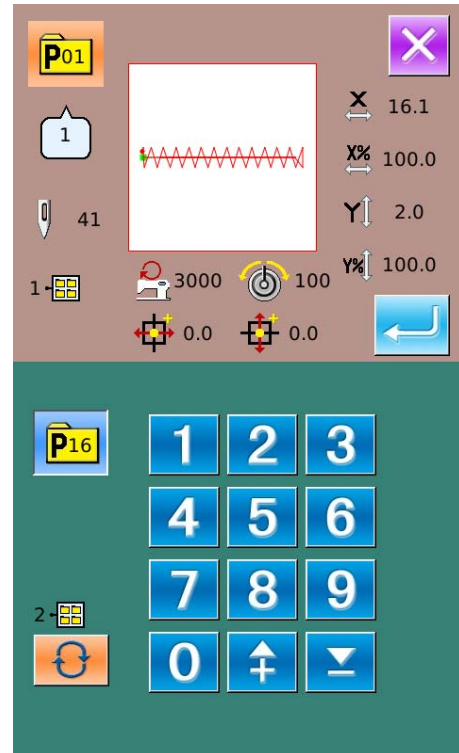

**3.4 P Pattern Selection**

**①Have Access to P Pattern Selection Interface**

As shown in right picture, user can press Key (A) to have access to P Pattern Selection Interface

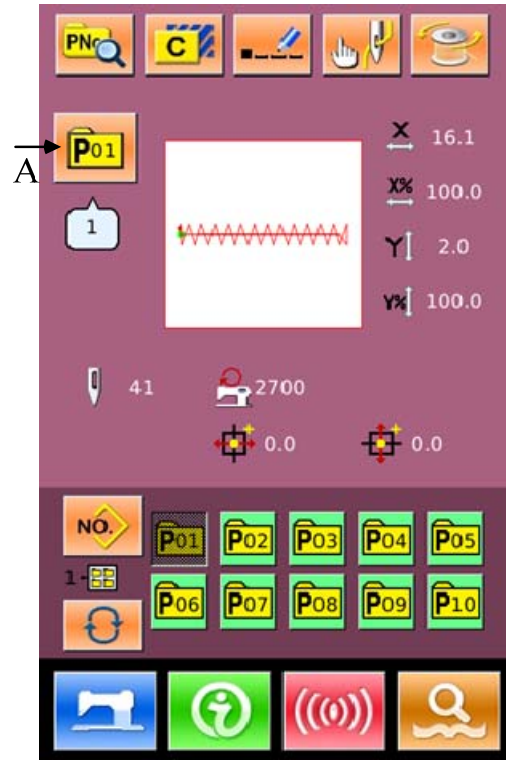

**②Select Pattern Number**

The relating information of the currently selected pattern is displayed at the upper side of the interface.

When user presses  to shift the status of concealing the file folder number, the entire registered P patterns can be displayed.

**③Confirm the Selection of Pattern**

The operation is same to that of normal pattern selection. Press  to end the selection.

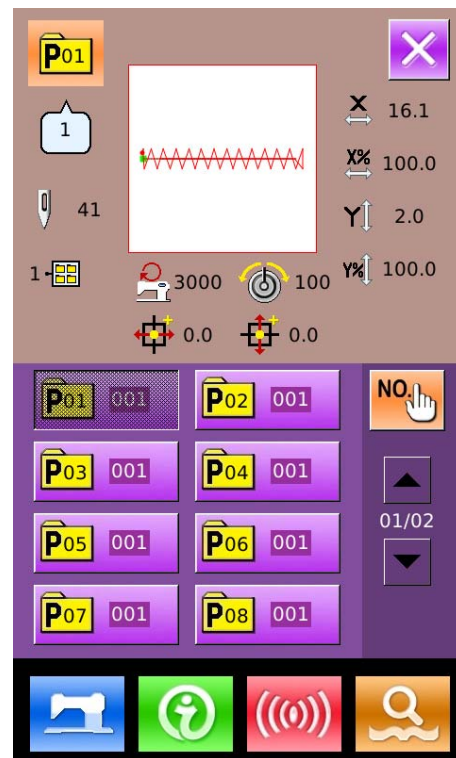

### 3.5 P Pattern Sewing

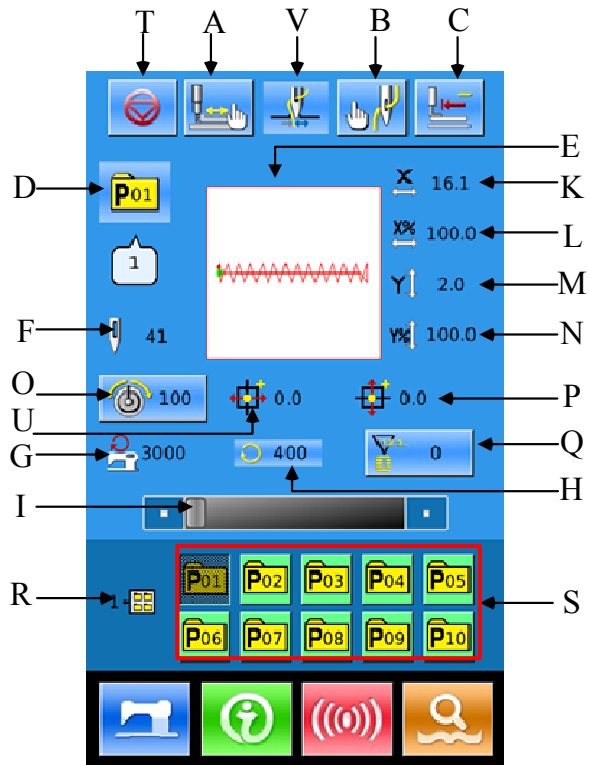

At the Interface for Inputting P Pattern

Data, User can press  to have access to the Sewing Interface (as shown in right).



**List of Functions Keys:**

No.	Functions	Content
A	Trial Sewing	Press it to have access to Trial Sewing Interface, where user can determine the shape of f pattern.
B	Threading	Press it to lower the presser.
C	Return to Origin	Press it to have the presser return to the start point.
D	P Pattern Number Display	Display the number of the currently selected pattern.
E	Sewing Shape Number Display	Display the number of the normal pattern quoted in the existing P pattern.
F	Pattern Stitch Number Display	Display the sewing stitch number of the currently selected pattern
G	Max Speed Limitation	Display the Max Speed Limitation

No.	Functions	Content
H	Sewing Speed Display	Display the current sewing speed
I	Sewing Speed Setting	Change the sewing speed
K	X Actual Size Display	Display the X actual size of current pattern
L	X Scale Rate Setting	Display the X scale rate of current pattern
M	Y Actual Size Display	Display the Y actual size of current pattern
N	Y Scale Rate Setting	Display the Y scale rate of current pattern
O	X Travel Amount Display	Display the X travel amount of the currently selected pattern
P	Y Travel Amount Display	Display the Y travel amount of the currently selected pattern
Q	Counter Setting	Press it to set the type and the present value of counter.  : Sewing Counter  : No. Pieces Counter
R	P Pattern File Folder Number Display	Display the file folder number of the current P pattern
S	P Pattern Selection	Display the registered P pattern
T	Pause	Press it to stop machine. It is controlled by parameter U31. When user selects Panel at that parameter, the screen will display the pause key. Other options will not display that button on screen.
U	Thread Tension Setting	Press it to enter the interface for setting thread tension.
V	Thread-catching	Select the effective/ ineffective of thread-catching function. It is affected by parameter U35.

## 4 Operations on Combination (C) Pattern

### 4.1 C Pattern Data Input

The combination pattern, called as C pattern for short, consists of a group of P patterns, which can contain 50 sub-patterns at most. In this model, 50 C patterns can be registered into the system at most.

For having access to the Interface of Combination Pattern Data Input (as shown at right), please refer the content in [8.8 Change Sewing Type]

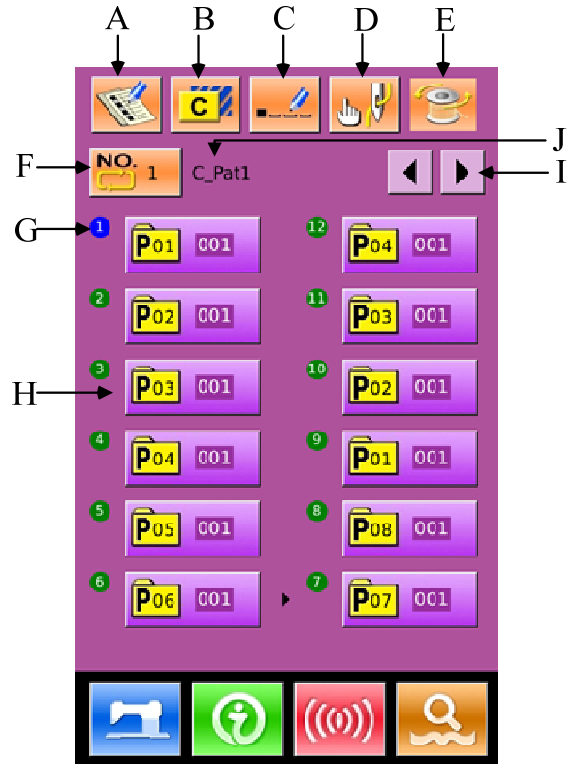

#### List of Function Keys:

No.	Function	Contents
A	C Pattern Registration	Register a new C pattern.
B	C Pattern Copy	Copy the content of Current C pattern to an empty pattern number.
C	Pattern Naming	14 figures can be inputted at most.
D	Threading	Press it to lower the presser.
E	Winding	Wind the thread with a press on  .
F	C Pattern Number Selection	The number of the currently selected pattern is displayed on the button. Press it to have access to the C Pattern Selection Interface.



No.	Function	Contents
G	Sewing Sequence Display	Display the sewing sequence of the currently selected pattern. The pattern with a blue marks is the initial sewing pattern.
H	C Pattern Shape Selection	Press it to have access to C Pattern Edition Interface. Operator can select a P pattern to input.
I	Page	30 C patterns can be registered at most, and 6 C patterns can be displayed on each page at most.
J	C Pattern Name	Display the Name of C pattern.

### 4.2 C Pattern Edition

#### ①Have Access to C Pattern Edition Interface

At Interface of C Pattern Data Input, user can press A to have access to C Pattern Edition Interface.

In initial status, because no sewing shape is registered to P pattern, the first one is displayed as blank.

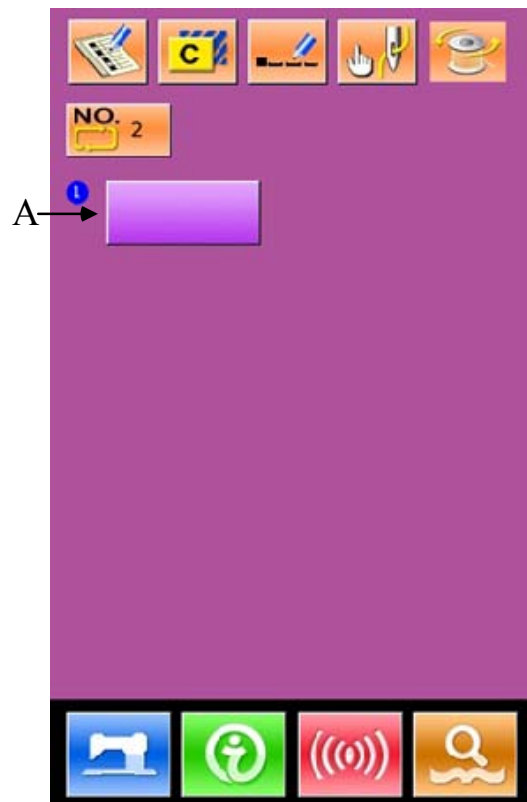

**②Select Shape**

At C Pattern Edition Interface (the right figure), user can select the P Pattern (B) for registration

and then press  to finish the selection.

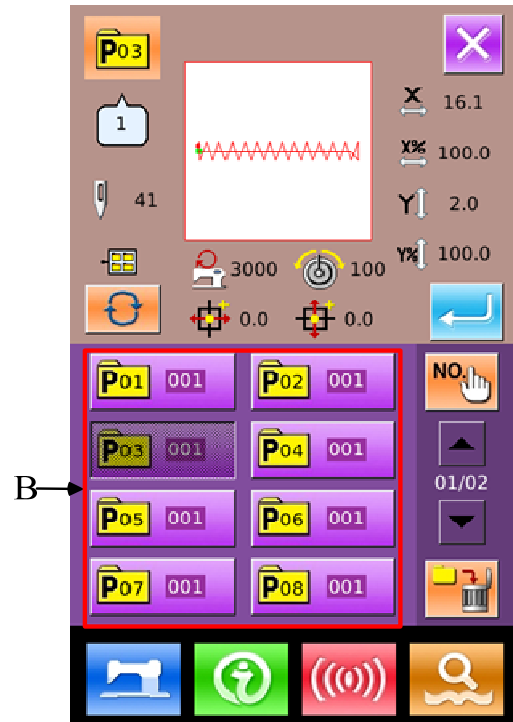

**③Repeat the Registration**

When the 1<sup>st</sup> pattern is registered, the Selection Key (C) for the 2<sup>nd</sup> pattern is displayed. Repeat the operations at above so as to register other patterns.

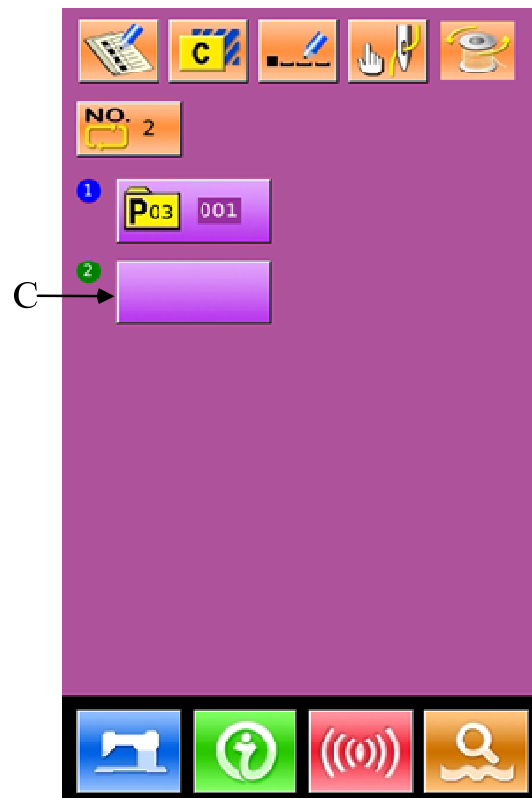

### 4.3 C Pattern Selection

① Have Access to C Pattern Selection Interface

As shown on the right picture, user can have access to C Pattern Selection Interface by pressing Figure A.

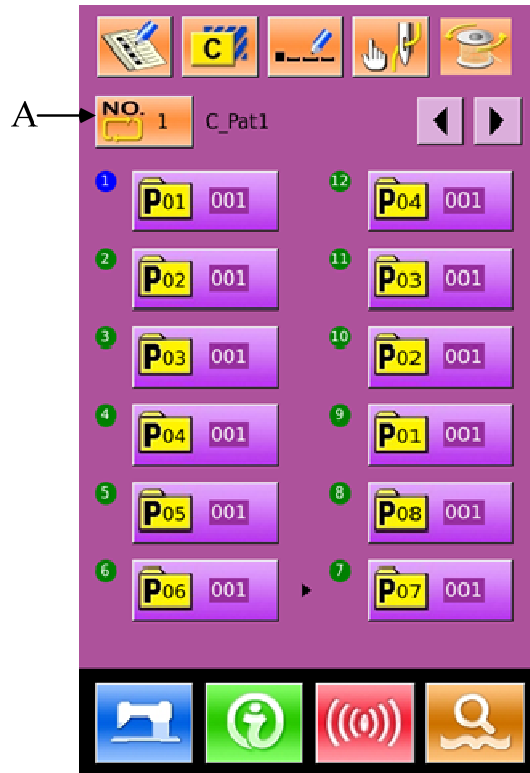

② Select C Pattern Number

At C Pattern Selection Interface (the right figure), user can press B to change the data information of P patterns within the current C pattern in sequence.

Confirm the number of the needed C pattern

(C), and then press  to finish selection

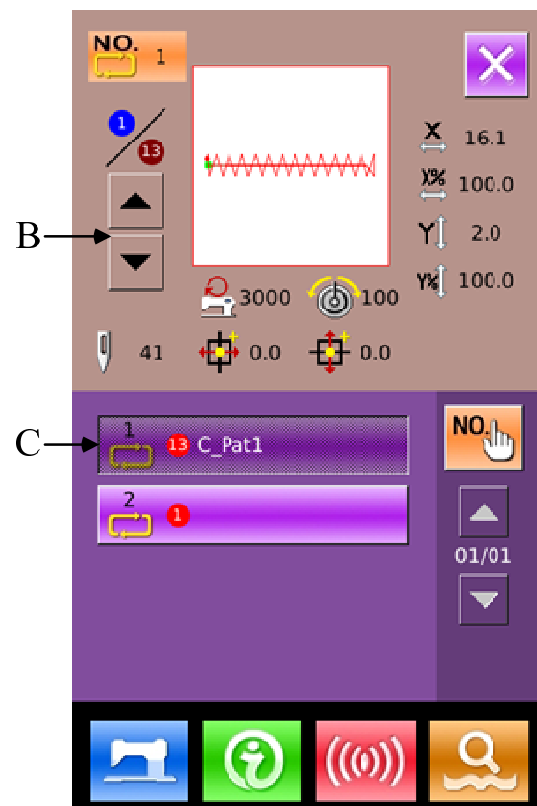

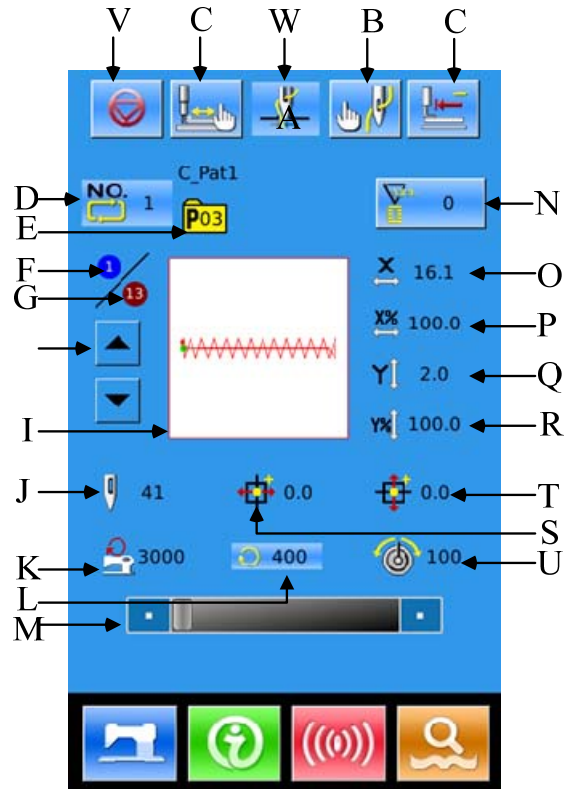

### 4.4 C Pattern Sewing

At Interface of C Pattern Data Input, user can press  to have access to Sewing Interface (as shown in right picture).



**List of Function Keys:**

No.	Functions	Contents
A	Trial Sewing	Press it to have access to Trial Sewing Interface, where user can determine the shape of f pattern.
B	Threading	Press it to lower the presser.
C	Return to Origin	Press it to have the presser return to the start point.
D	C Pattern Number	Display number of current C pattern
E	Sewing Shape Number Display	Display the number of the sewing shape registered under the current C pattern
F	Sewing Sequence Display	Display the sewing sequence number at current pattern
G	Total Number Display	Display the total number of sub-patterns registered in the

No.	Functions	Contents
		current C pattern
H	Sewing Sequence Forward/Backward	Select the previous or next shape for sewing.
I	Pattern Shape	Display the shape registered at current sewing
J	Patten Stitch Number Display	Display the stitch number of the shape registered at current C pattern.
K	Max Speed Limitation Display	Display the Max speed at sewing this shape
L	Sewing Speed Display	Display current sewing speed
M	Sewing Speed Setting	Enable to change sewing speed
N	Counter Setting	Press it to set the type and the present value of counter.  : Sewing Counter  : No. Pieces Counter
O	X Actual Size Display	Display the actual size of the selected pattern in X direction.
P	X Scale Rate Setting	Display the X scale rate of the selected pattern.
Q	Y Actual Size Display	Display the actual size of the selected pattern in Y direction.
R	Y Scale Rate Setting	Display the Y scale rate of the selected pattern.
S	X Travel Amount Display	Display the X travel amount of the currently selected pattern
T	Y Travel Amount Display	Display the Y travel amount of the currently selected pattern
U	Thread Tension	Display the basic value of thread tension
V	Pause	Press it to stop machine. It is affected by Parameter U31. Select "Panel" to display

<b>No.</b>	<b>Functions</b>	<b>Contents</b>
		the pause button on screen. Other options will not display the figure on screen.
W	Thread-catching	Select the validity and invalidity of thread-catching function. It is affected by parameter U35.

## 5 Pattern Edition

### 5.1 Have Access to Pattern Edition Mode

User can press  to shift the data input interface to the Mode Selection Interface (as shown at right picture), where user can make some detailed settings and editions.



For the detailed operations and settings at Mode Selection Interface, please refer to【8 Mode and Parameter Setting】.





Press  to shift with .

 : Sewing Mode

 : Edition Mode

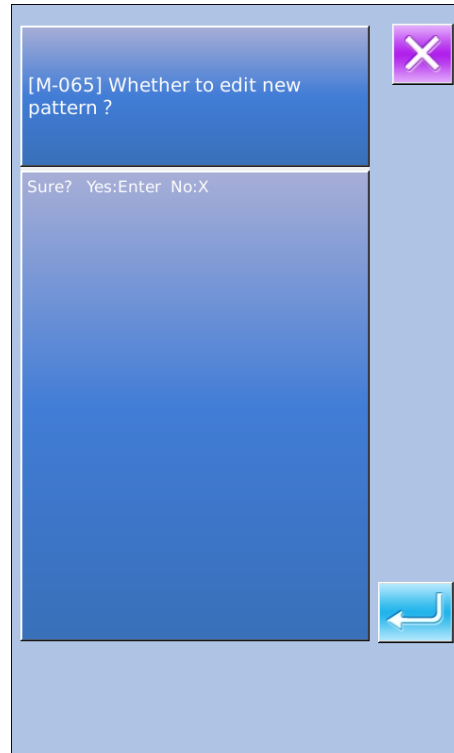
Select , and then press  again to quit the Mode Selection Interface. At this moment, the system will ask user whether to have access to Pattern Edition Interface.





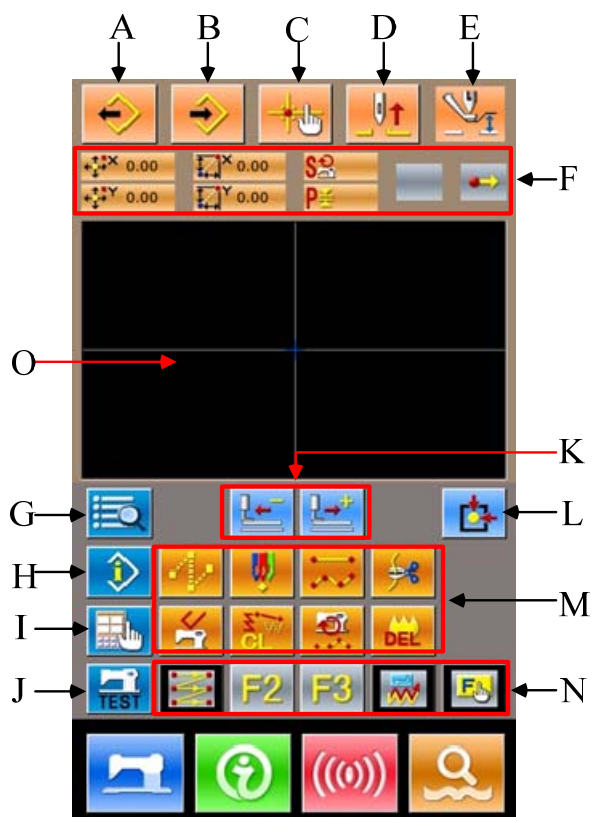







Press  to have access to Standard Interface for Pattern Edition, as shown in the right picture:











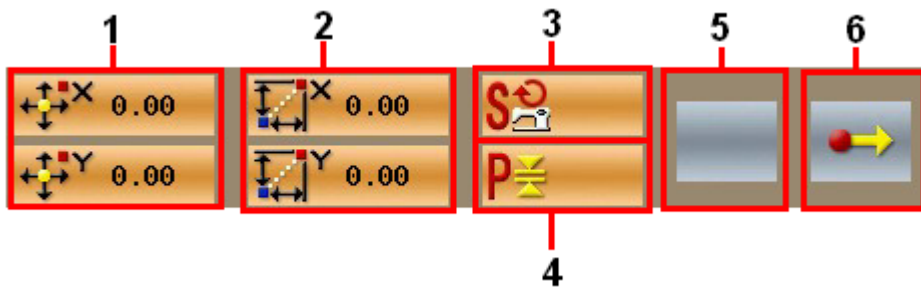

**List of Function Keys:**

No.	Function	Contents
A	Load Pattern	Display the Pattern Loading Interface
B	Input Pattern	Display the Pattern Input Interface
C	Needle-entry Point Inquiry	Promptly locate the needle entry point; when editing the patterns, user can input the coordinates of the sewing point directly.
D	Lift needle	Make needle return to the highest point
E	Move Intermediate Presser	Lift or lower the intermediate presser
F	Current Needle Position Information	Display the position information of needle at present
G	Code List	Display the entire available editing functions. Please refer to [List of Editing Functions] for details.
H	Information Display	Display the detailed information of the currently edited pattern
I	Display Setting	Enable wide-angle setting, needle entry point display setting and so on
J	Trial Sewing	Sew the currently edited pattern through a trial sewing
K	Forward· Backward Feeding	Move one stitch from the current position (forwards  ; backwards  )
L	Return to Origin	Return the needle from current position to origin
M	Function Keys	Call the functions on the buttons directly
		1  : Empty feeding
		2  : Point Sewing
		3  : Normal Sewing
		4  : Thread-trimming
5  : Cancellation of Mechanical Control Order		

No.	Function	Contents
		 6 <b>CL</b> : Element Deletion  7 <b>S</b> : Changes on Sewing Speed Section  8 <b>DEL</b> : Delete Current Pattern
N	Hot Keys	By using Function of Selection and Setting (Function Code 112), user can distribute the needed functions to each button. After the distribution, the figure of that function is displayed in the corresponding key.
O	Pattern Shape Display Area	Display the pattern



No.	Item	Content
1	Absolute Coordinate	The absolute coordinate of current needle position to the origin
2	Relating Coordinate	The relating coordinate of current needle position
3	Speed	The sewing speed or empty feeding speed of current point.
4	Interval	The length of current element stitch. (If the stitch is scaled, the value before the scaling will be displayed.)
5	Type of Element	Types of current elements. At setting sewing data, the system will displayed the element types, like jump feed  , broken line  , free curve  and so on). At setting the mechanical orders, the type of the control order will be displayed (like thread-trimming).
6	Types of Needle	The types of the needle entry position:

No.	Item	Content
	Entry	 Start of Design: the start point (Origin) of a design.
		 Middle Point of Element: the middle point of the element (neither the top point nor the ending point of the element).
		 Top Point: the top point of a broken line.
		 End Point of Element: the ending point of the element
		 End Point of Pattern: the ending of pattern.

### 5.2 Pattern Edition

Use Function of Pattern Edition to input the following pattern.

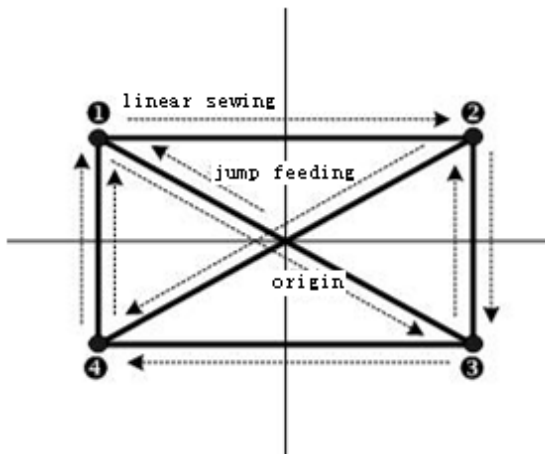

Input Point:

	X (mm)	Y (mm)
①	-40.00	25.00
②	40.00	25.00
③	40.00	-25.00
④	-40.00	-25.00

Input Order: It is shown as the dotted arrow in the left.

**① Input of Empty Feeding**

At Standard Interface for Pattern Edition,

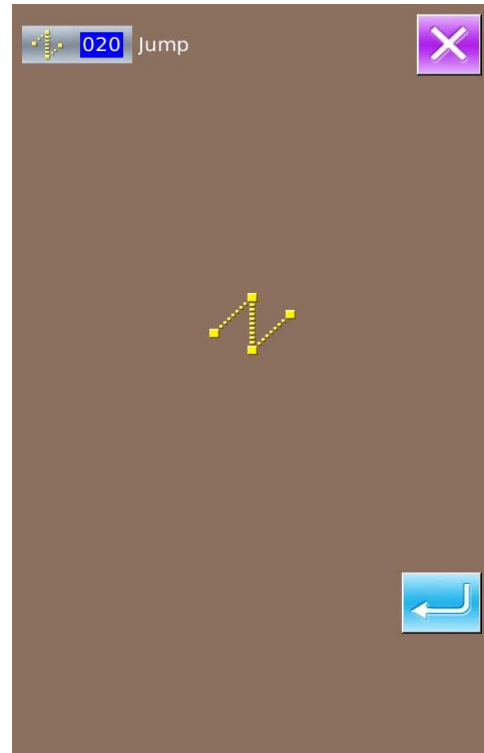

user can press  to activate the Interface for Setting Empty Feeding:

Note: user can also select “020: Empty Feeding” from function code list to enter the interface



After user presses , the Interface for Locating the Empty Feeding Position will be displayed:

At that Interface, user can use Direction Key (A) to move the icon (needle position) to the position with coordinate (0, 10). After

pressing  for confirmation, user need press  to save the settings. After that,

the system will return to the Standard Interface for Pattern Edition and display the empty Feeding stitch

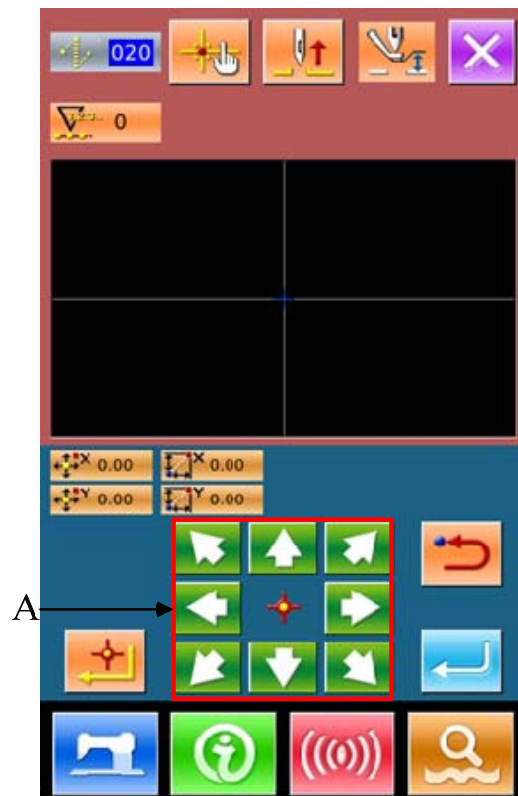

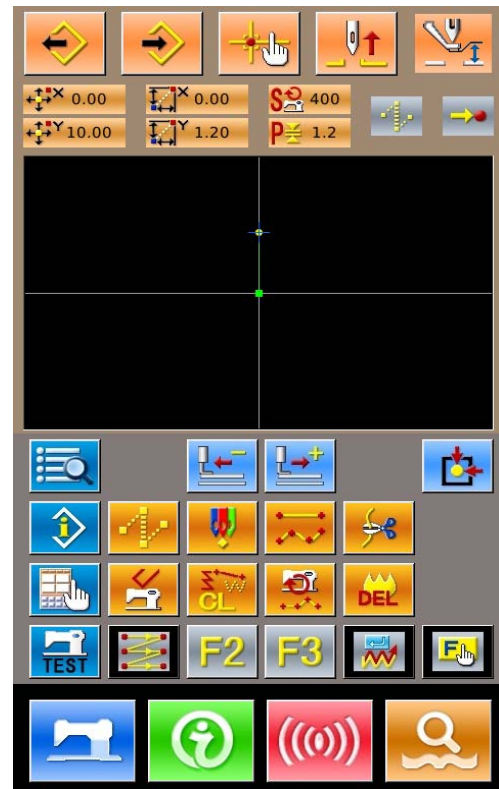
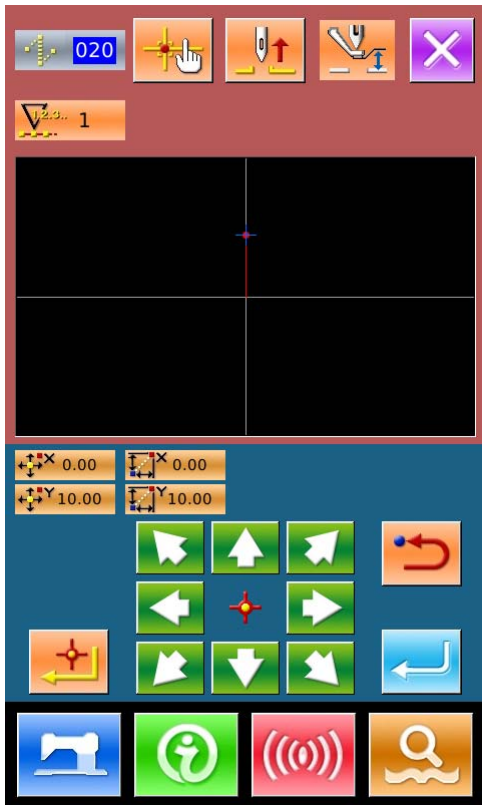



② Input of Linear Normal Sewing

At Function Code List, select “023 Linear Normal Sewing”, and then press  to have access to Interface for Setting Linear Normal Sewing



At Interface for Setting Linear Normal

Sewing, press  to have access to the interface for setting the sewing stitch length, as shown in right picture.

Press  and  in order to change the sewing length to “3.0”, and then press “ENTER” to save value and have the system return to the Interface for Setting Linear Normal Sewing

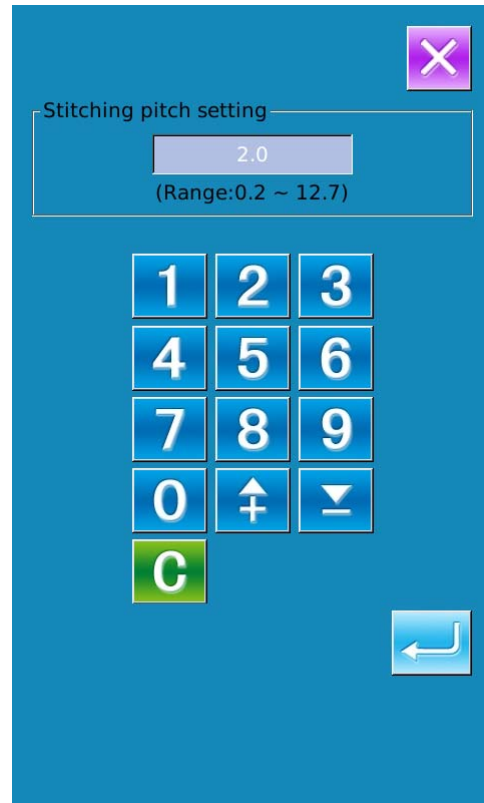

Note: Press  to clear the value.

After confirming the value “3.0mm” as the length of sewing stitch, user can press  to have access to the Interface for Setting Linear Normal Sewing.

In that interface, user needs press Direction Keys to move the icon (where the needle

locates) from **1** to **2**, and then press .

Repeat the above operations to move the icon in the order

of **2** → **3** → **4** → **1** → **3** → **2** → **4** → **1**

, as shown in right picture.

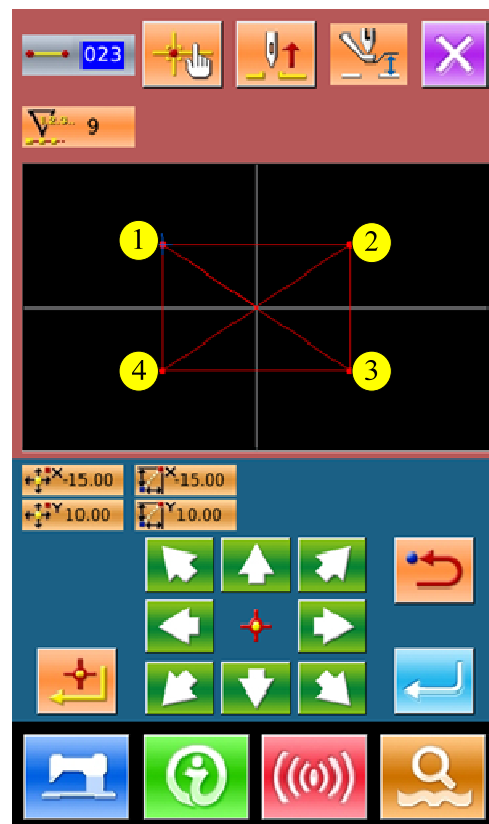



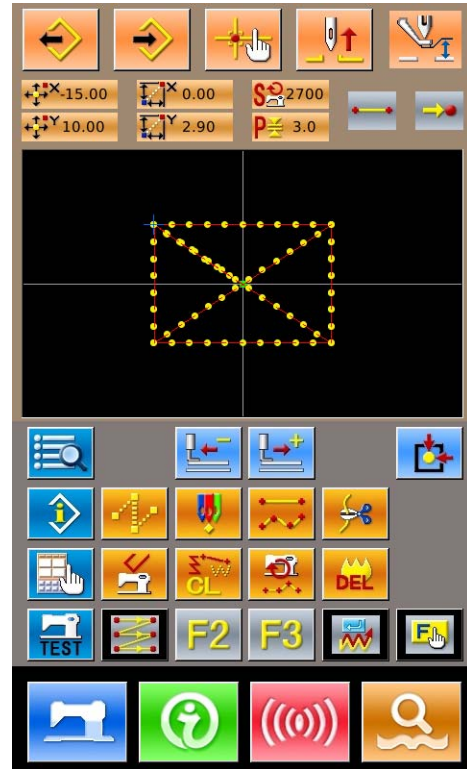

After confirming the pattern design, user can p  
 to create the pattern data and have syste  
 return to Standard Interface for Pattern Edition  
 where the pattern will be displayed.





**③ Save Pattern**

Press  to have access to Pattern Saving  
 Interface to save the edited pattern, as shown in  
 right pictures.

The system will set the pattern number  
 automatically; user can also input the value with

 ~  and keyboard or  / .

With  and , user can select the  
 location for saving the pattern. Both the U disk  
 and the memory on operation panel will be  
 available for saving the pattern.

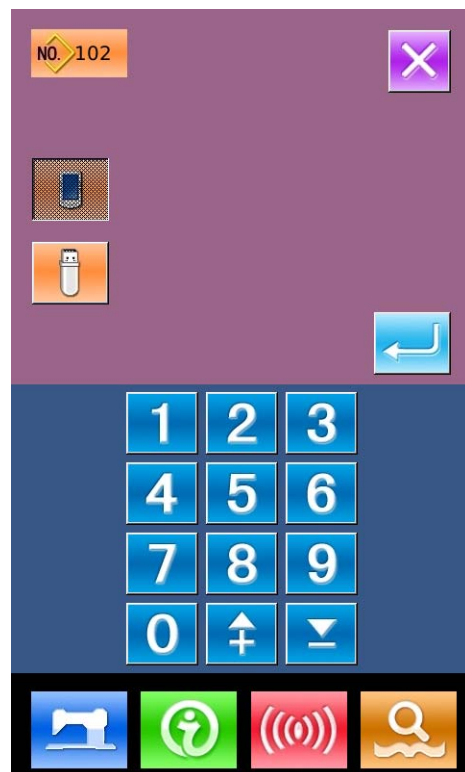

Press  to save pattern. Then the system will ask user whether to insert thread-trimming automatically, as shown at right picture.

Press  to add automatic thread-trimming action;

Press  to cancel the insertion of automatic thread-trimming action

After the operations, the system will return to Standard Interface for Pattern Edition.

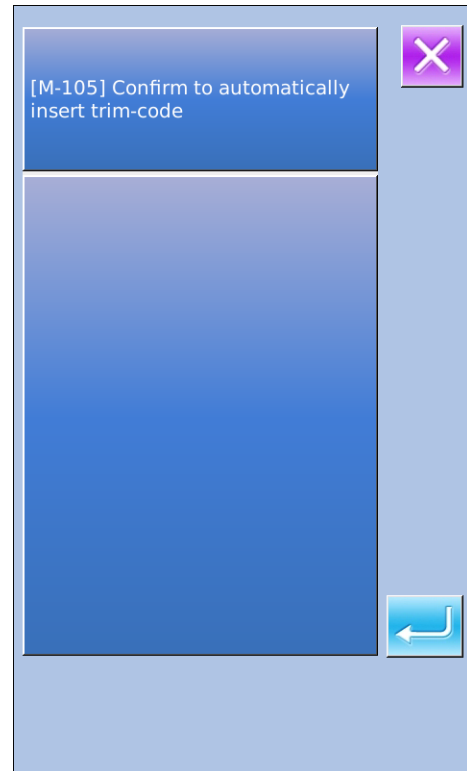



**For the detailed operations and instructions of pattern edition, please refer to <SP510 Pattern-making Operation Manual>.**



### 5.3 Quit Pattern Edition Mode

At Standard Interface for Pattern Edition, user can press  to have access to Mode Selection Interface, as shown at right picture.



Press  to shift to  :

 : Edition Mode

 : Sewing Mode

Press  again to quit the Mode Selection Interface. At this moment, the system will ask user whether to return to Sewing Mode.

Pressing  is to quit from Pattern Edition Mode and to head for Sewing Mode.

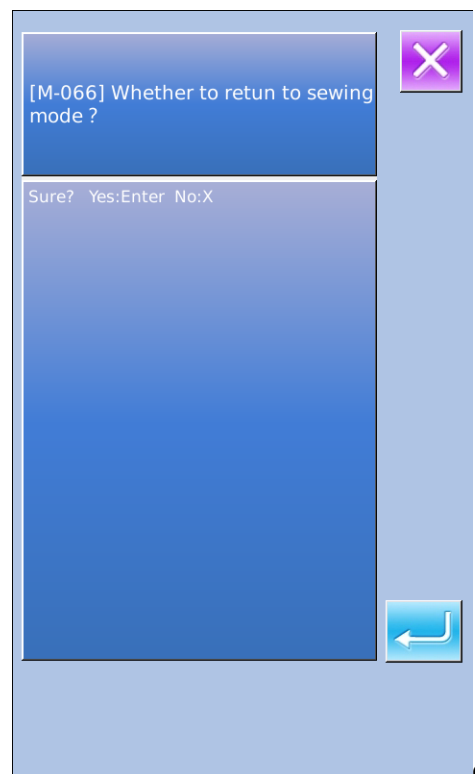

## 6 Information Functions

The Information Functions contain the following three functions:

- 1) The oil replacement (grease-up) time, needle replacement time, cleaning time, etc. can be specified and the warning notice can be performed after the lapse of the specified time.
- 2) Speed can be checked at a glance and the target achieving consciousness as a line or group is increased as well by the function to display the target output and the actual output.
- 3) Display the threading picture

### 6.1 Maintenance & Repair Information

#### ① Display Information Interface

At Sewing Data Input Interface, user can Press Information Key (A) to activate the Information Interface.

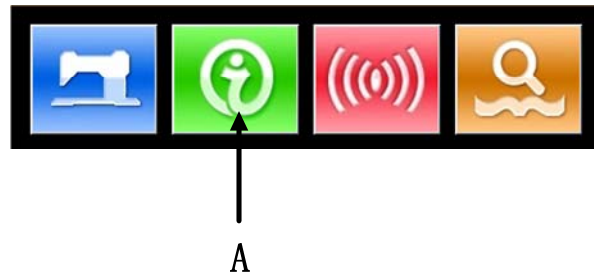

#### ② Display Maintenance & Repair Interface

Please press  (B) at Information Interface

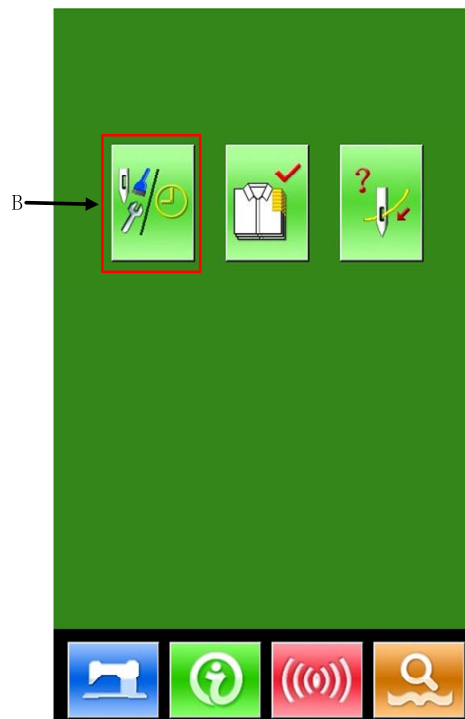

At Maintenance & Repair Interface, the system will display the information of the following three items



: Needle Replacement (Thousand

Stitches)\

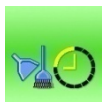

: Cleaning Time (Hour)



: Oil Replacement Time (Hour)

The figure of each item is displayed on the button (C), the time interval for the repair notice is displayed at (D), and the time left to the replacement is displayed at (E)

Additionally, the time left to the replacement can be cleared by users.

Press  to quit to information interface.

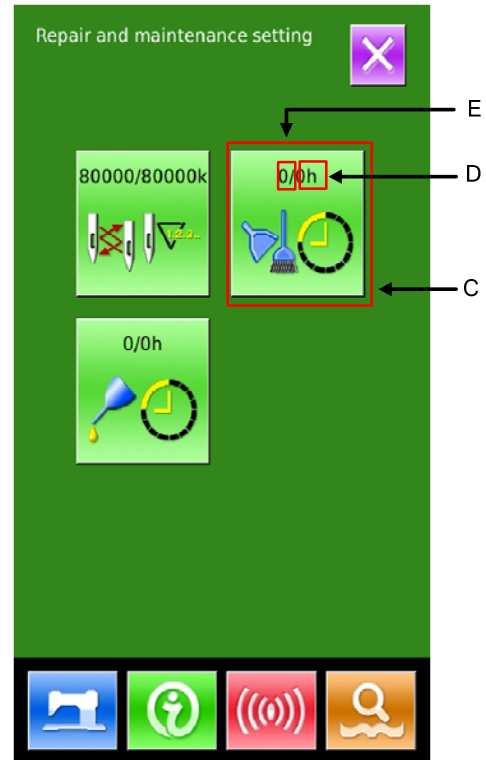

## 6. 2 Input Time for Maintenance & Repair

### ① Display Information Interface (Maintenance Level)

At Interface for Inputting Sewing Data, user can hold the Information Key (A) for about 3 seconds to activate the Information Interface (Maintenance Level).

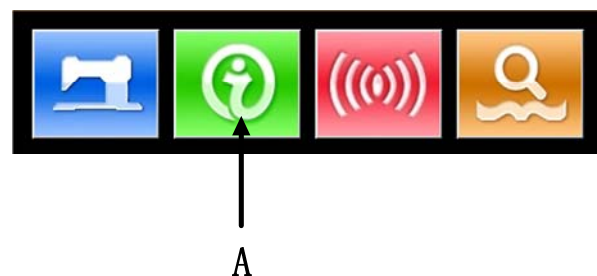

At that level, there are 6 buttons displayed on the interface

## ② Information Interface

At Maintenance level, there are 6 functions displayed as below:



: Maintenance & Repair



: Production Control



: Threading



: Alarm Record



: Running Records



: Periodical Password

Please press Maintenance & Repair Information

Key  (B) to activate the interface.

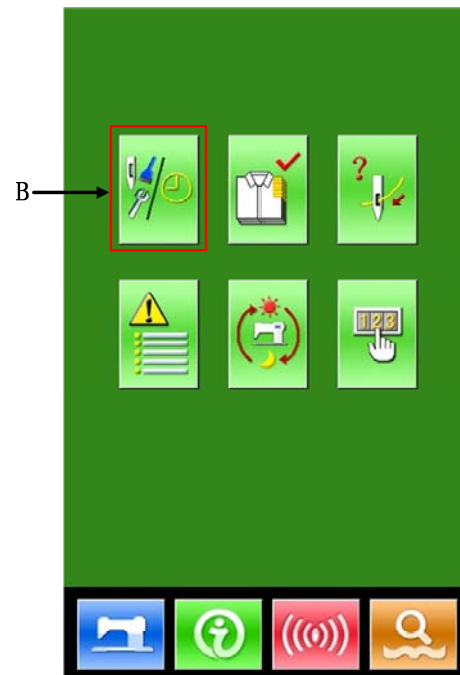

### ③ Setting of Maintenance & Repair

At Maintenance & Repair Information Interface, the information displayed is as same as that on the ordinary Maintenance & Repair Information Interface. Press the Item Button C (for changing the repair and maintenance time) to activate the relating input interface.

Exp. Pressing  is to set the cleaning time

Press  to return to the information interface directly

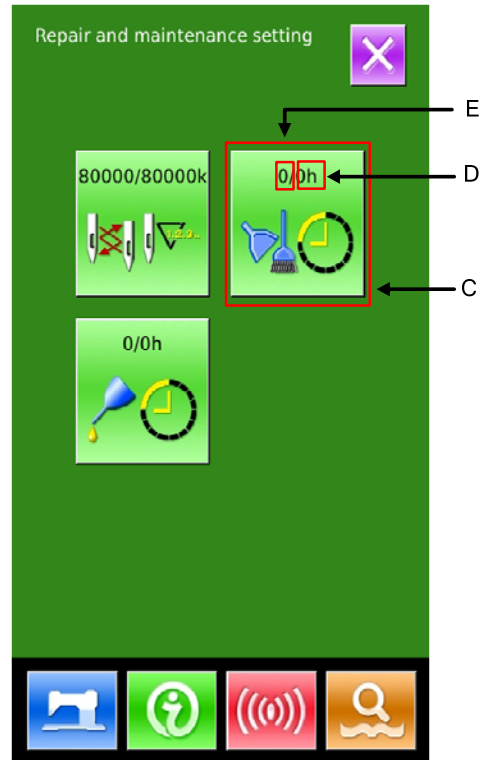

### ④ Set Maintenance & Repair Item

If the value of this item is set at 0, the function of maintenance & repair will be stopped.

The items for setting include:

- ◆ Needle Replacement Time
- ◆ Cleaning Time
- ◆ Oil Replacement Time

Press the figure to enter the corresponding interface:

A、 Input the value via keyboard

B、 Press  to confirm the input.

C、 Press  to return to the interface for repair & maintenance directly

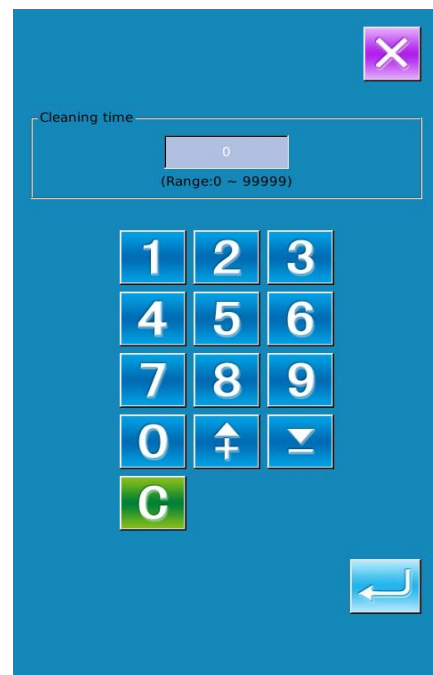

### 6. 3 How to Release Alarm

When it comes to the pointed time for maintenance or repair, the system will activate the prompt interface. If user wants to clear the maintenance and repair time, please press . Before the clearance of the maintenance and repair time, the information prompt interface will be displayed after each one sewing task.

The following are the prompt code for each item

- Needle Replacement : M-052
- Oil Replacement Time: M-053
- Cleaning Time: M-054

### 6. 4 Production Control

In the interface of production control, the system will be able to display the amount of products from the beginning to now and the target producing amount, as long as the user fixes the time of start.

There are two ways to activate the production control interface:

- Via Information Interface
- Via Sewing Interface

#### 6. 4. 1 Via Information Interface

##### ①Display the Information Interface

At Interface for Inputting Sewing Data, press Information Key (A) to activate the Information Interface.

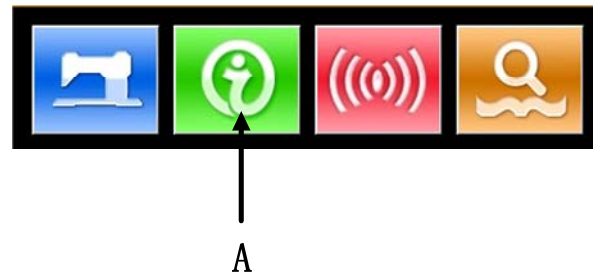

**②Display the Production Control Interface**

Please press Production Control Button (B) at the Information Interface so as to display the Production control interface ( as shown at right picture ) .

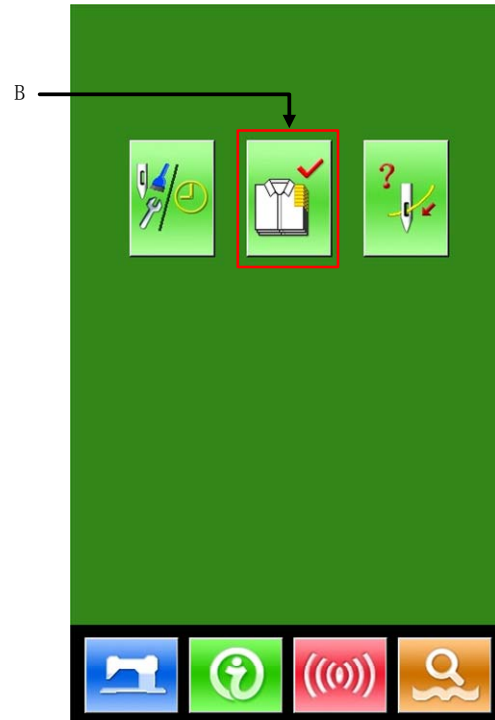

There are five items displayed on the production control interface

**A: Existing Target Value**

According to the pitch time, the target sewing amount up to now is displayed automatically.

**B: Actual Result Value**

Automatically display the amount of pieces sewn

**C: Final Target Value**

Set the final Target amount of production

**D: Pitch Time of Target**

Set the pitch time (Second) among each working process

**E: Unit Interval of Actual**

Set the actual time for finishing one process

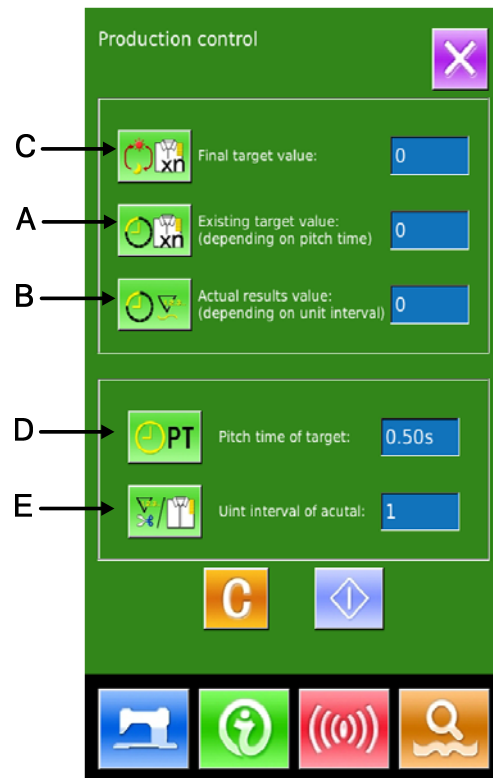

## 6. 4. 2 Via Sewing Interface

### ①Display Sewing Interface

At Interface for Inputting Sewing

Data, user can press  to activate the Sewing Interface.

### ②Display Production Control Interface

At Sewing Interface, user can press Information Key (A) to activate the Production Control Interface.

The displayed content and the functions are same to the content in Chapter 6.4.1 at above.

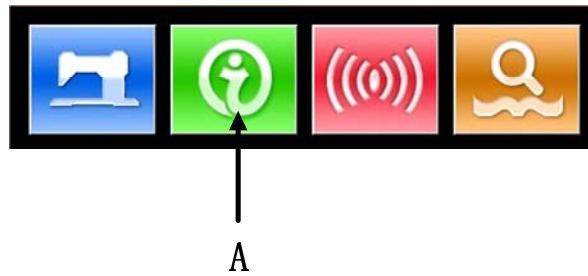



### 6. 4. 3 Setting on Production Control

#### ① Display Production Control Interface

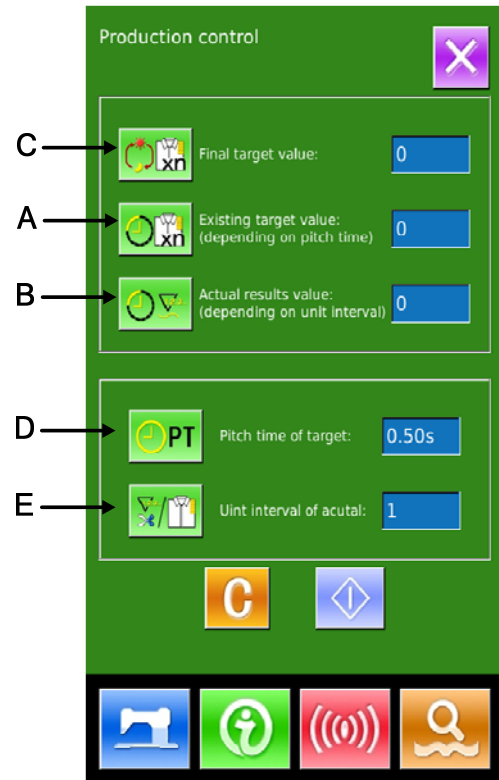

Press  to display the Production Control Interface



#### ② Input Final Target Value

Firstly, please input the number of production target pieces to which the sewing is performed from now on. Press Final Target Amount Key

 (C) to activate the Target Value Input Interface.

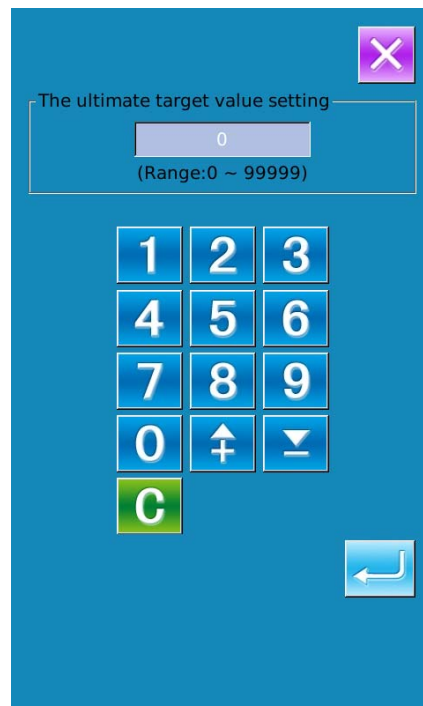

Please use the number keys or +/- keys to input the wished value. After the input, please press  to confirm. Press  to quit.



**③ Input Pitch Time of Target**

Then, input the pitch time needed for one process. By pressing the Pitch Time of Target

Key  (D), user can activate the Pitch Time Input Interface.

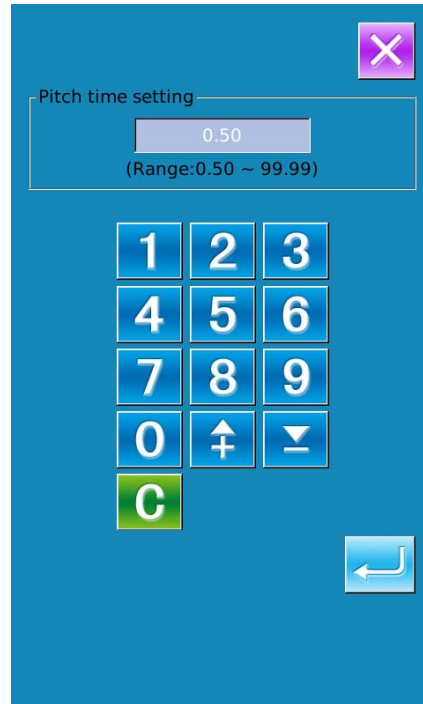

Please use the number keys or +/- keys to input the wished value. After the input, please press  to confirm. Press  to quit.



**⑤ Input Unit Interval of Actual**

Then, input the time for trimming at one process in average. By pressing Unit Interval

of Actual Key  (E) at previous page, the user can activate the Interface for Inputting Trimming Time

Please use the number keys or +/- keys to input the wished value. After the input, please press  to confirm. Press  to quit.

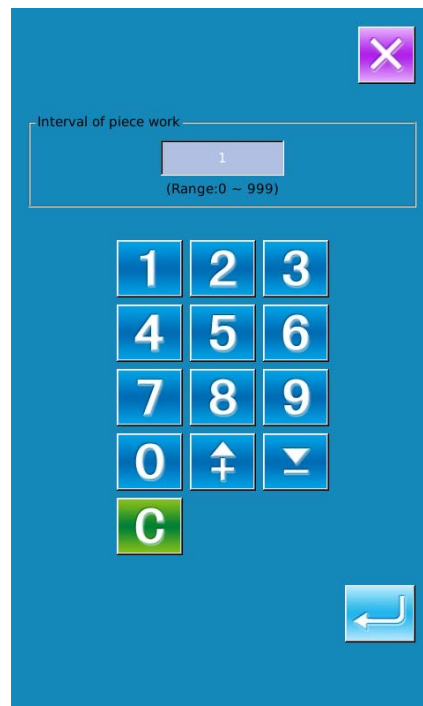

⑤Start to Count Amount of Production





Press  (I) to start counting the number of production amount, the [Final Target Amount], [Target Amount at Present] and [Actual Amount] will turn to dark. **Final Target Value:** Can be used as the time reference

**Existing Target Value:** The target value adds 1 after each time pitch set [Pitch Time of Target]

**Actual Result Value:** After entry from the “6.4.2 Via Sewing Interface”, the system will start count the actual value by adding 1 at finishing each piece

**By setting the Target Value and the Actual Result Value, user can find out the change of productivity.**

⑥Stop Counting

In the status of counting, you can see the  displayed on the screen. Press  to stop counting. After stop, the Counting Key  will take the position of . If user wants to continue counting, please press .

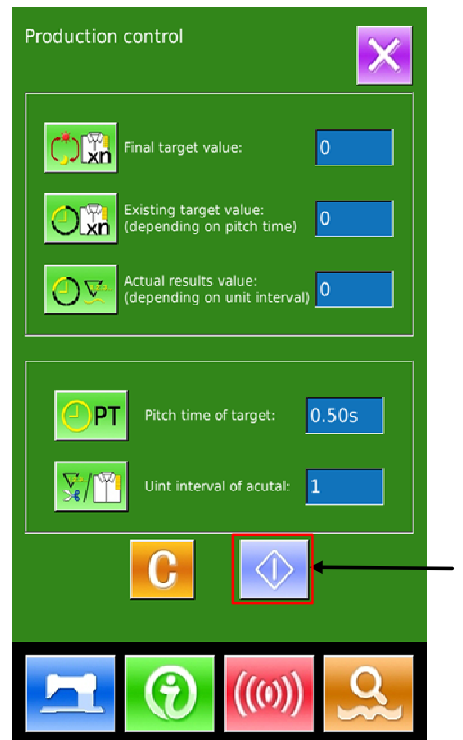

Without pressing , the value will be kept.

Press  to quit directly



⑦ **Clear the Data in Counter**

For clearing the value of the counter, the user should stop the counter at first and then press .

The values of  and  can be cleared both.

(Note: the clear key can only be displayed when the counter is stopped.)

After pressing , the Interface for Confirming Clearance is activated.

In the Interface for Confirming Clearance,

user can press  to confirm the

clearance. Press  to quit.

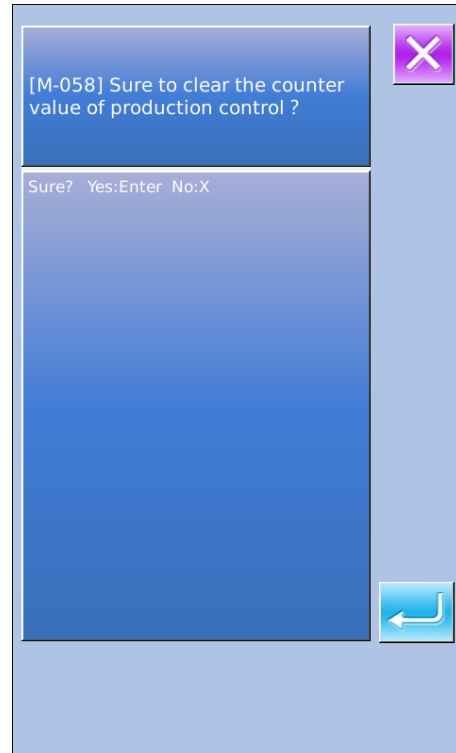

**6. 5 Display Threading Figure**

At Information Interface, user can press

Threading Button  (C) to activate the Threading Figure, which can be taken reference when user threads the machine.

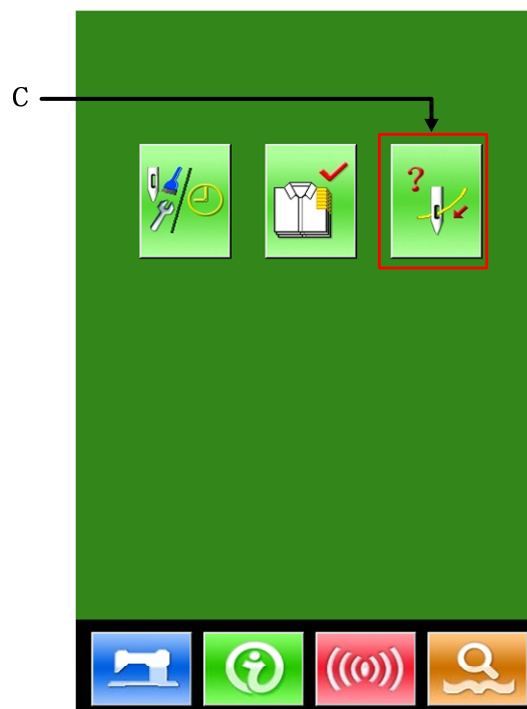

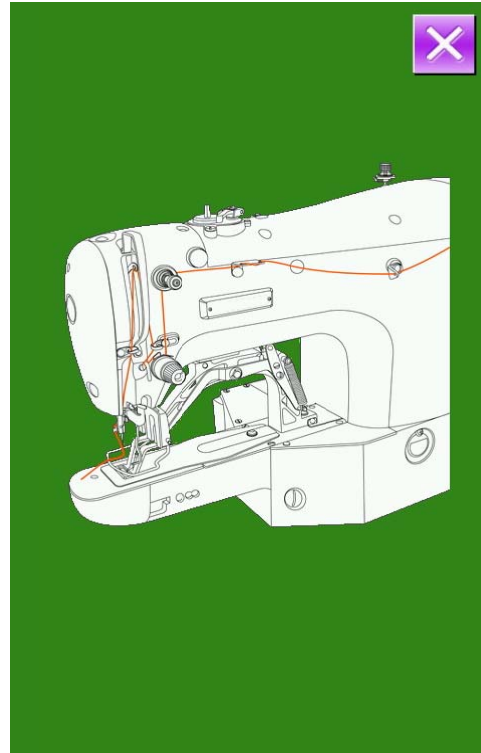

## 6. 6 Alarm Record

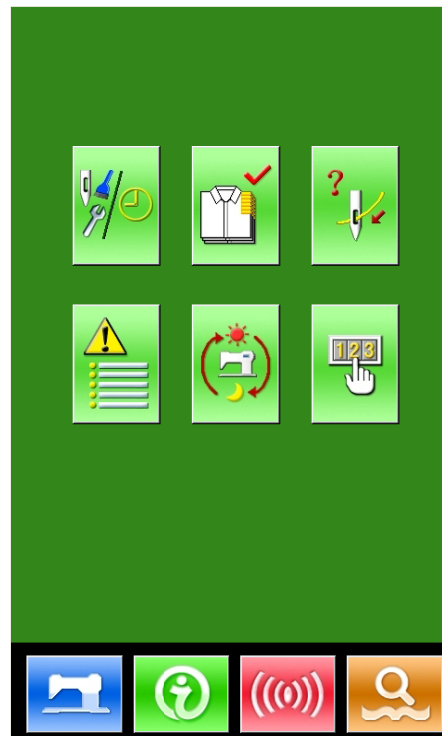

- ① At Maintenance Level, press  to inquire the alarm records.



② Press  to check the records

As in the picture, the warning information and the times of occurrence are displayed

Function of Keys:

A、 Press  or  to turn pages

B、 Press  to quit the inquiry

C、 Press  to clear the filed record

③ Press the number key at the left of the column to display the details of the warning records

Press  to quit

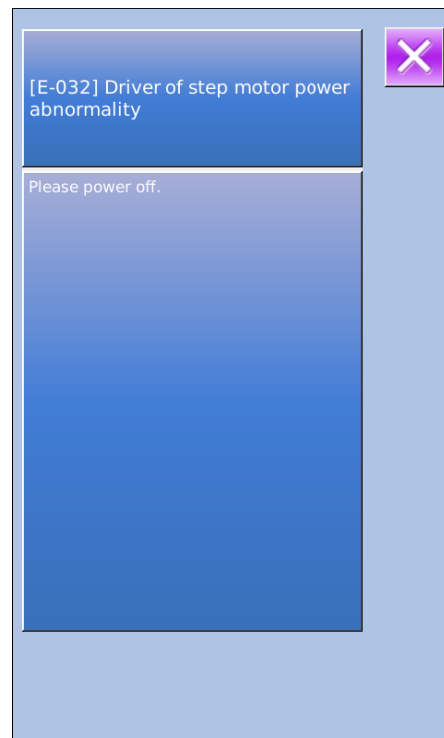
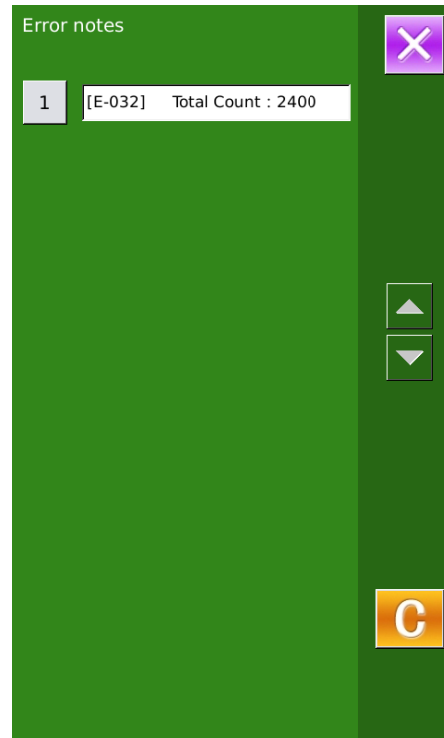

## 6.7 Running Record

① In the interface of maintenance level, press



to check the running information of the machine

② **The Running Records contain:**

- a) :Accumulated running time (Hour)
- b) :Accumulated times for thread trimming
- c) :Accumulated time of power-on (Hour)
- d) :Accumulated number of stitch (1000stitch)

A、 Press  to quit

B、 Press Clear to clear the record

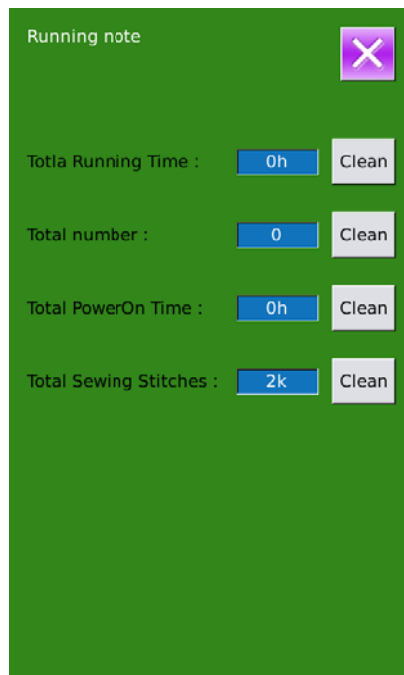
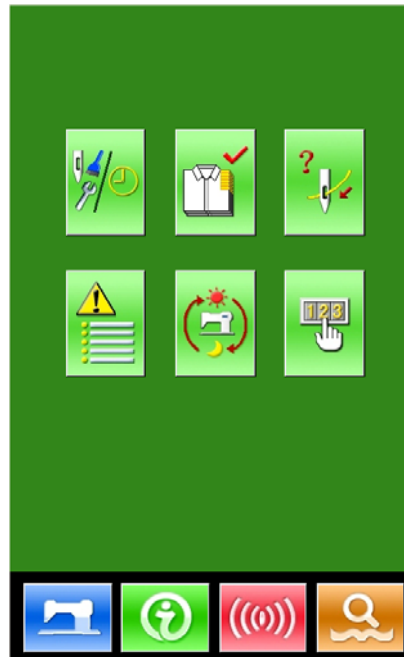

## 6.8 Setting of Periodical Password

1) In maintenance level, Press  to set periodical password

In this interface, the system will ask user to input the User ID. Input the right manufacturer ID to enter the password management mode, where user can set and manage the periodical passwords.

- ◆ At most ten periodical passwords with different activation dates can be set
- ◆ The system will display the information of passwords set by manufacturer.

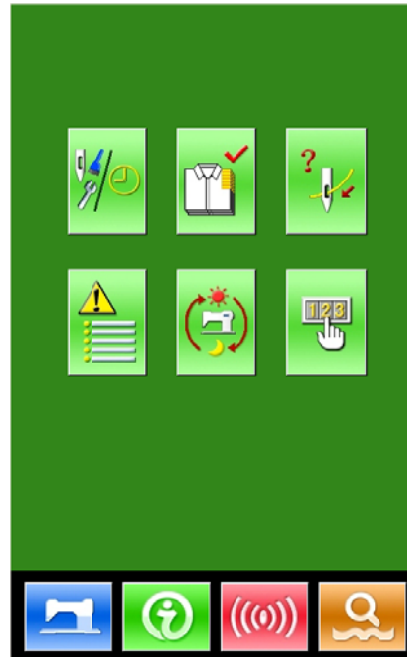

2) Press  To input User ID

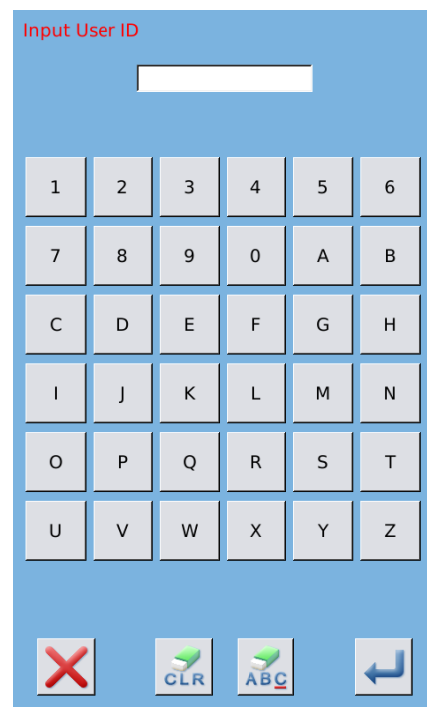



**3) Input the Correct Factory ID to enter the password setting interface**

Procedure for setting the periodical password:

- A、Continue inputting other periodical passwords



**4) Input Board Number**

Press **【Board Number】** to enter the board number input interface. Input the board number and press  to finish the input

- ※ **The board is a four-figure number, from 0~9999**

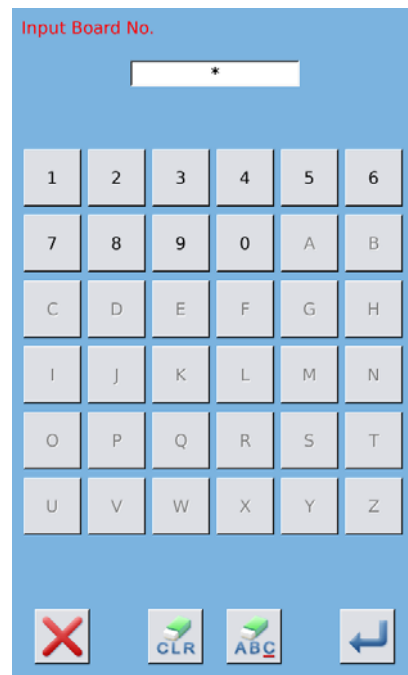

**5) Input System Clock**

Press **【Clock】** to enter the interface for setting the system clock. And set the time.



**6) Input the super password**

Press the **【Super Password】** to enter the interface for setting super password

- ※ **At most, nine super passwords can be input**
- ※ **At the password confirmation, make sure the two input passwords are same**

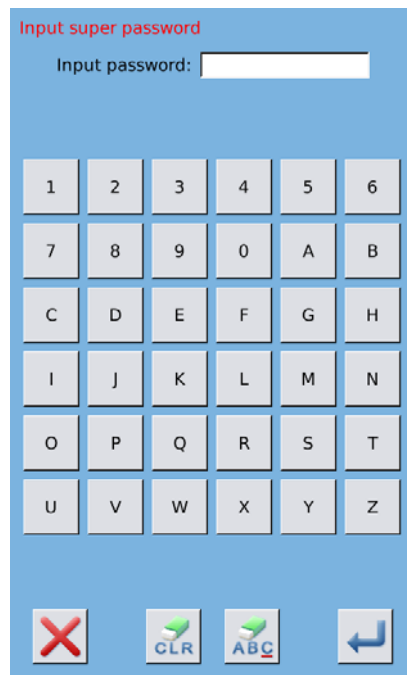

**7) Input periodical password**

Press **【 Password-1 】** to enter the first password date, where user can input the first date for activation. After selecting the proper date, user can press  for confirmation. Then enter the password setting interface to input the password.

- ※ **The date should not be earlier than the system date**
- ※ **At the password confirmation, make sure the two input passwords are same**

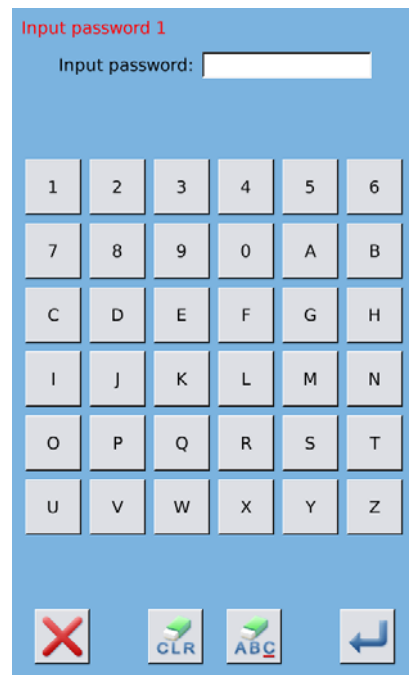

**8) Input other periodical password**

The setting of other periodical password is same to that in step ⑦. Please take the reference to that

- ※ **The next activation date shall be later than the previous date.**



**9) Save Password**

A、 After inputting the password, please press



to save it.

B、 After the password is saved, the system will display **【Save the password successfully】** . Press



to finish the operation and return to the main interface of information.

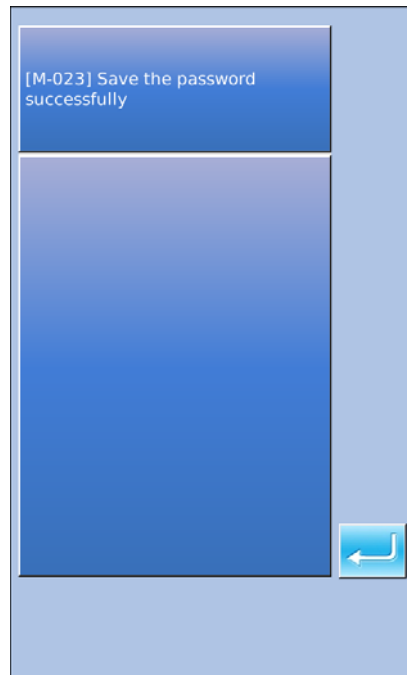

**10) Clear Password before Activation**

It is to clear the passwords before its activation.

- A、 The method for entering the password interface is same to that of the password setting
- B、 Input the right factory ID to activate the right interface.
- C、 The system will display current clock and the activation dates
- D、 Press  to delete the password orderly

Input the right periodical password to clear the current password. If the super password is input, all passwords will be cleared;

After the deletion of the password, the date of that password will be displayed in red.

If all the passwords are cleared, the system will automatically quit to the main interface of information.



**11 Clear Password at Activation**

If the system has password and that password is still effective, it will be activated at the activation day.

If user wants to use the machine he should input the right password.

A、 The effective passwords include current password and super password

B、 If the current password is input, the current password will be deleted. After user clears the current password, if it is the last password in machine, no more activation of password will

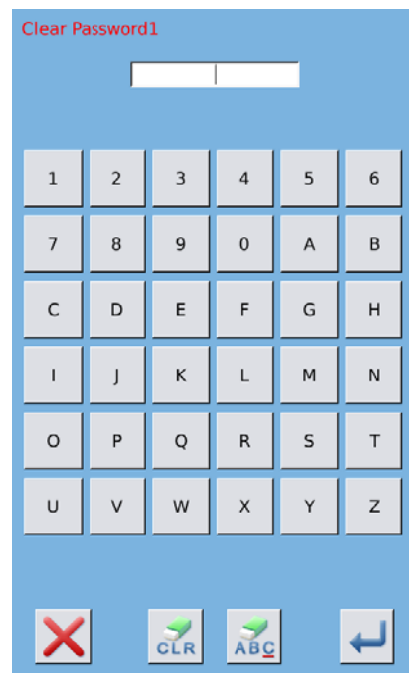

happen in future.

C、If the super password is input, all the periodical passwords will be deleted.

## 7 Communication Functions

At Communication, user can perform the following functions:

- Download the sewing data made at other sewing machines or produced by the pattern-designing software to the sewing machine;
- Load sewing data to U disk or computer
- Load parameters from U disk
- Input the parameters within the operation panel to U disk
- Update the software within the operation panel

### 7.1 About the Available Data

The available data is shown at below, as well as the data type:

Data Type	Standard Type
VDT	[0-9][0-9][1-9].vdt
DXF	[0-9][0-9][1-9].dxf
DST/DSB	[0-9][0-9][1-9].dst/ [0-9][0-9][1-9].dsb
B/BA	[0-9][0-9][1-9].(1-599) / [0-9][0-9][1-9].(600-999)
PAT	[0-9][0-9][1-9].pat

When saving data to the U disk, user needs save it to the DH\_PAT folder. Otherwise, the file is unable to be read.

## 7.2 Operations

### ① Display the Communication Interface

In the data input interface, press  to display the communication interface.

### ② Select the relating operations

The following three kinds of functions can be selected in this interface:

- Pattern Transfer
- Parameter Transfer
- Software Update

Click the corresponding figure to perform the operations.

### ③ Press to quit the Communication

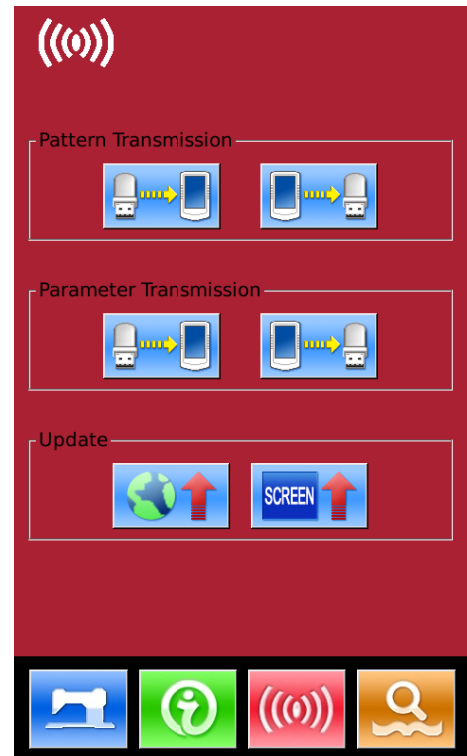

## 7.3 Pattern Transfer

### ① Display the Communication Interface

In communication interface, press:

A: Input patterns from U Disk to Operation

Panel

B: Output patterns from Operation Panel to U

Disk

Path of U Disk: DH\_PAT

- ※ **When inputting patterns from U disk, user has to save the pattern into the DH\_PAT in the U disk.**
- ※ **When outputting patterns from operation panel, user has to save the pattern into the DH\_PAT in the U disk.**
- ※ **Naming Method of Patterns within U Disk**



**When inputting patterns from U disk, user needs follow the naming rule at below::**

**File Name: 3 figures, 001~999**

**Suffix: vdt** (no matter at CAP or not)

**Example:**

**Right Names:** 100.vdt、102.VDT



**Other naming methods are wrong, which can not be recognized by machine**

② Press button A to enter the interface for inputting patterns from U Disk

**Note:** If the pattern in U disk has the same name to the pattern within the panel, the pattern number will be displayed in red. The pattern with red code can only be inputted with button F, as shown in figure 1

A、Use 【Up Arrow】 , 【Down Arrow】 to turn the page

B、Use these three methods to select patterns

- Press  to select all the patterns
- Press  to select in contrary way
- Input Pattern Number

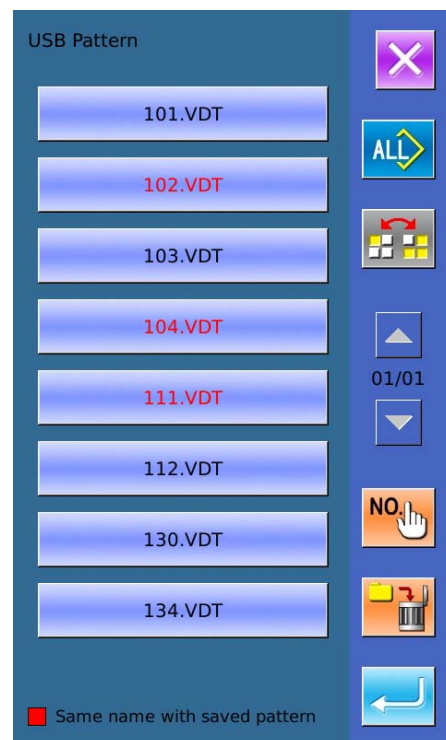



Figure 1

C、 Press  to finish pattern input. At this moment, the patterns inputted and the patterns selected share the identical pattern number, as shown in figure 2

D、 Press  to delete the selected pattern

E、 Press  to quit Communication Interface

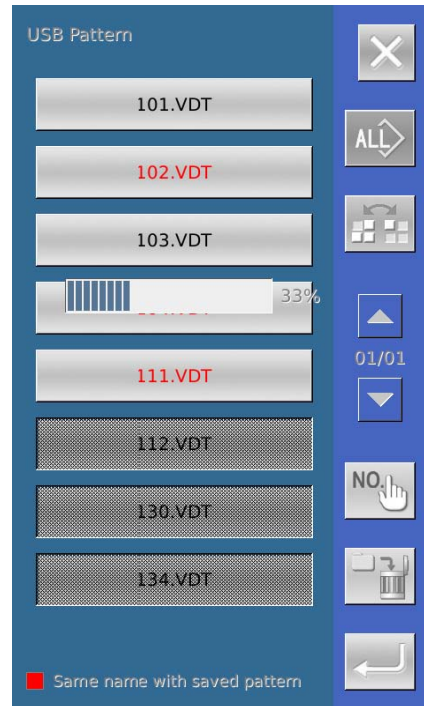



Figure 2

F、 Select a pattern and then press  to display the interface shown as figure 3.

Input the pattern number for saving;

G、 If user selects several patterns, he will be unable to perform the above operation. Press

 to quit to the previous r interface

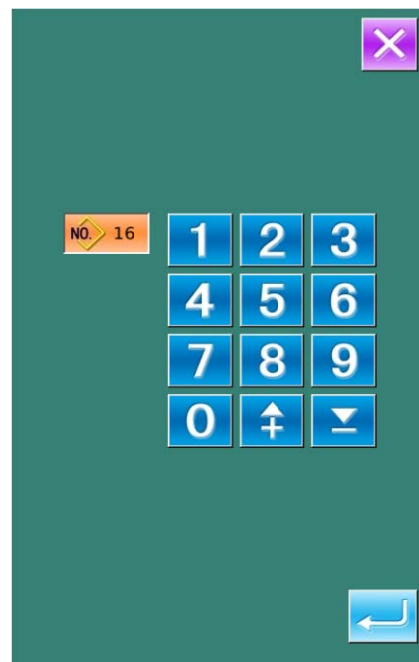

Figure 3

**Attention: If the selected pattern number**

exists in operation panel, the screen as the figure 4 will be displayed. If the data is in other format, the panel will automatically turn it to the vdt format and save it into memory.

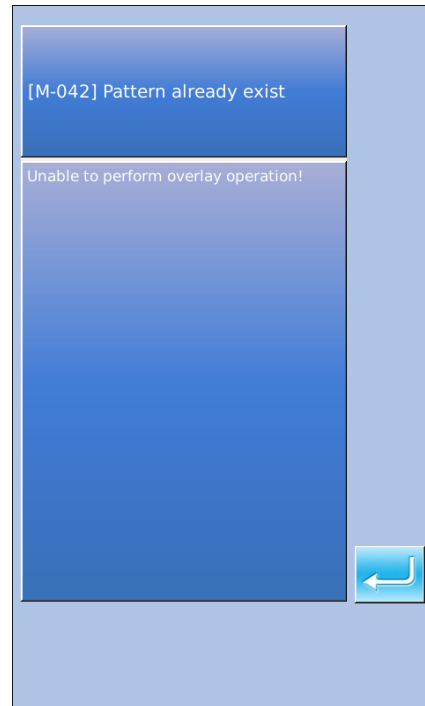





Figure 4

③ Press Button B to enter the interface for outputting patterns from panel to U Disk.

A、A、 Use 【Up Arrow】 , 【Down Arrow】 to turn the page

B、 Use these three methods to select patterns

- Press  to select all the patterns
- Press  to select in contrary way
- Input Pattern Number

C、 Press  to delete the selected pattern

D、 Press  to finish pattern output

E、 Press  to quit Communication

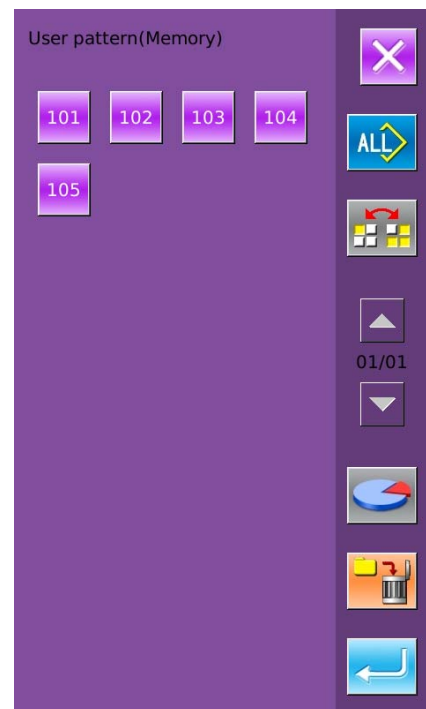

Interface

F、 In this interface, press  to display the free room of the memory and the number of pattern.

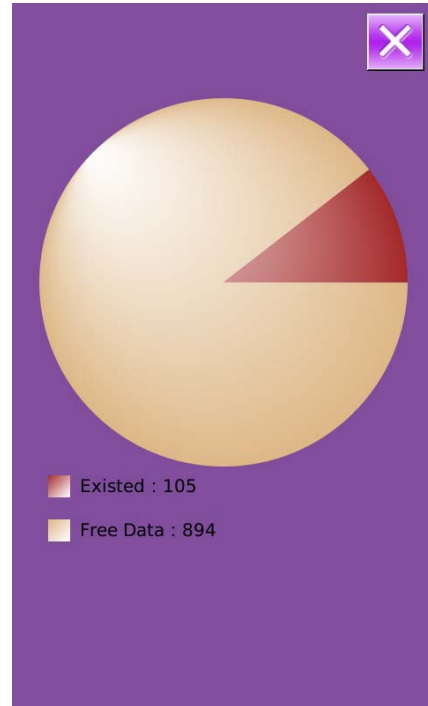

### 7. 4 Parameter Transfer

#### ① Display the Communication Interface

In communication interface, press:

A: Input parameters from U Disk to Operation Panel

B: Output parameters from Operation Panel to U Disk

- ※ **When inputting patterns from U disk, user has to save the parameters into the DH\_PARA in the U disk with name ukParam.**
- ※ **When outputting patterns from operation panel, user has to save the parameters into the DH\_PARA in the U disk with name ukParam.**
- ※ **The parameter file is the binary file, which is operated on the control panel. User can not change that file manually on PC, or the file may be damaged**

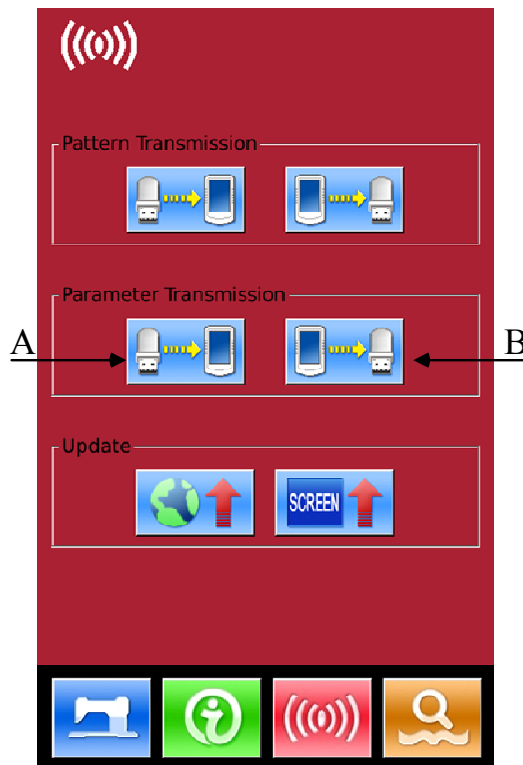

② **Press Button A to Input Parameters from U Disk to Operation Panel**

A、Press  to input the parameters and quit

B、 Press  to quit directly.

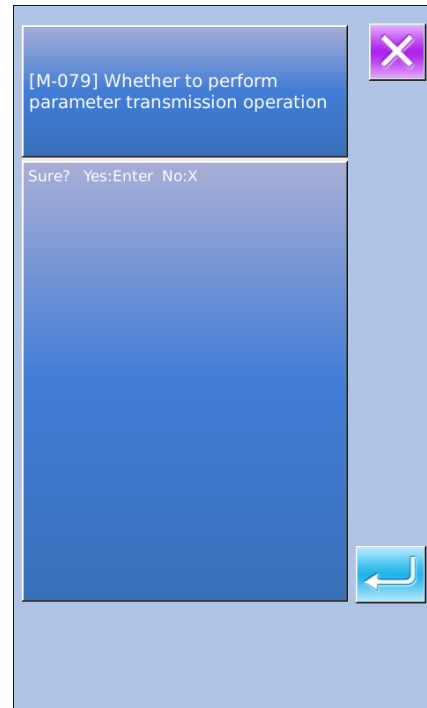

③ **Press Button B to Output Parameters to Operation Panel**

A、 Press  to output parameters from operation panel to U disk and quit

B、 Press  to quit directly

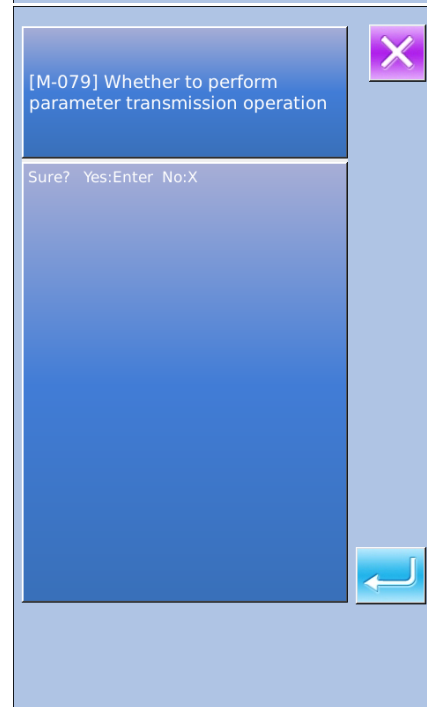

## 7.5 Software Update

### 1) Display the Interface

In Communication interface, press A to enter Software Update Interface

### 2) Update Selection

The software update contains:

- ◆ Operation Panel Software
- ◆ Icon
- ◆ Font
- ◆ Power-on Screen

Press  and  to turn the page

A、 Press  to finish the selected update and quit

B、 press  to quit directly

C、 User can select several items for update at same time. The system will perform the update according to the order

D、 After the update, please restart the machine.

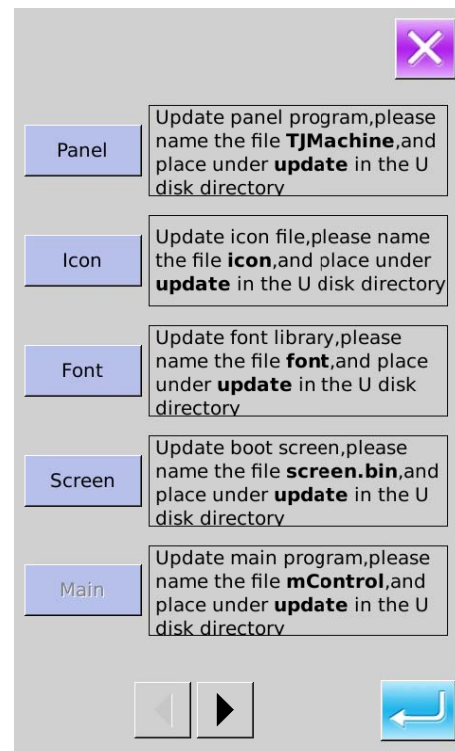

**3) Press B to enter the interface for updating the power-on screen**

Put the bin file (generated from the power-on screen) into the “Update” catalogue in U disk. Select the bin file and

then press  to finish the update.

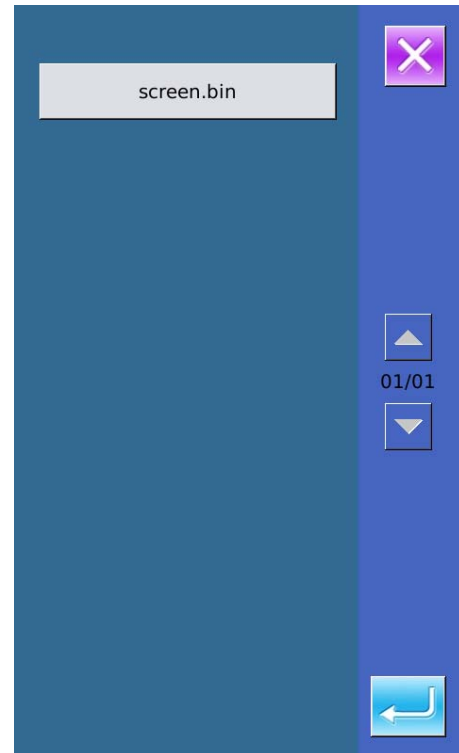

## 8 Mode & Parameter Setting

Press  to shift from the Data Input Interface to the Mode Interface (as shown in right figure), where user can perform some detailed settings and editions.

Hold  for 3 seconds to have access to Mode Setting Level 2 Interface; hold for 6 seconds to have access to Mode Setting Level 3 Interface.

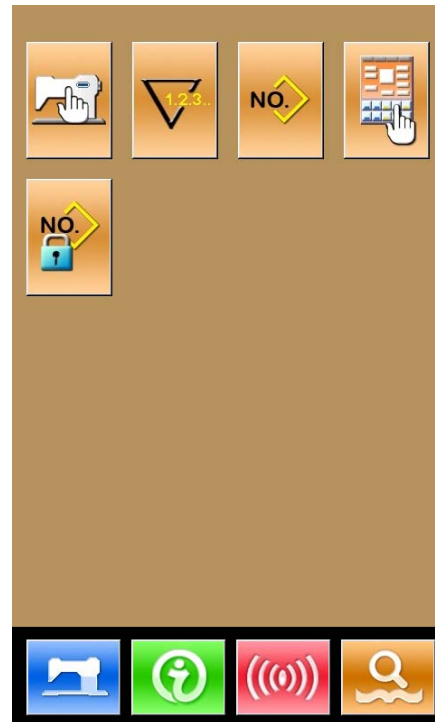

Mode Setting Level 2 Interface

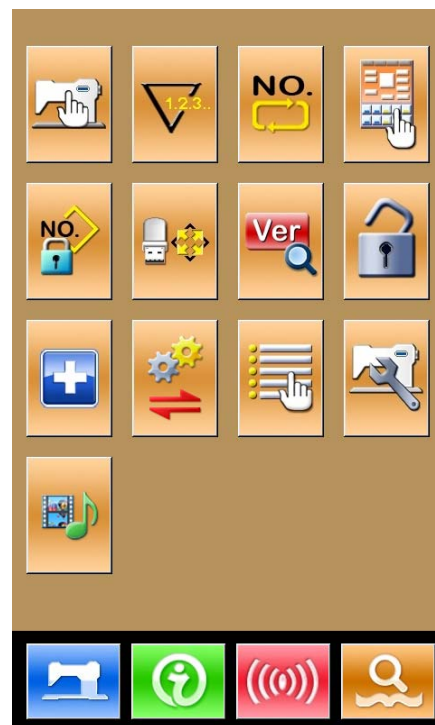

Mode Setting Level 3 Interface





## 8. 1 List of Function Keys

No.	Figure	Functions	Content
1		Level 1 Parameters Setting	Set the Level 1 (U) parameters
2		Counter Setting	Set the type of counter, counting value and default value
3		Sewing Type Setting	Shift between normal pattern sewing and combination pattern sewing
4		Pattern Lock	Enter the interface for locking pattern
5		Pattern Edition	Have access to pattern edition status
6		U Disk Initialization	Initialize the U disk.
7		Software Version Inquiry	Inquire the versions of the current panel, main controller and motor
8		Keyboard Lock	Lock some functions that can be set.
9		Test Mode	Set the mechanical devices and LCD
10		Parameter Back-up	Backup or recover the current parameters
11		Activate Parameter Edition	Activate or deactivate the edition of parameters
12		Level 2 Parameters Setting	Set the Level 2 (K) parameters
13		Play Video	Play the video

## 8.2 Level 1 Parameters Setting

### ① Set Parameter

Select  to enter the interface of Level 1 parameter setting (shown as the figure at right).

Press  to quit the setting interface. When some parameters are changed, the system will display the “Modified” in the parameter setting interface.

Select the parameter for changing; Then the system will enter the setting status. The parameters are separated as “Data Input Type” and “Selection Type”. Please refer to the example at below:

Select U01 and enter the interface below



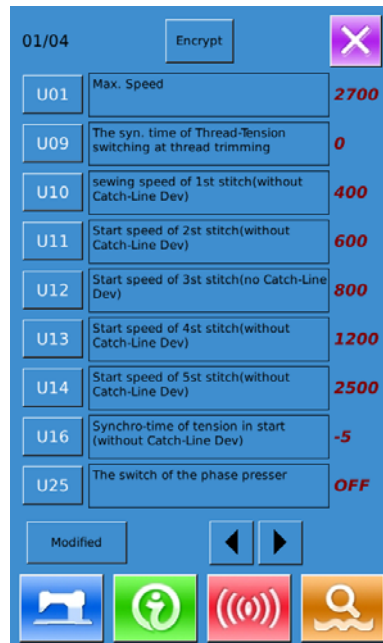
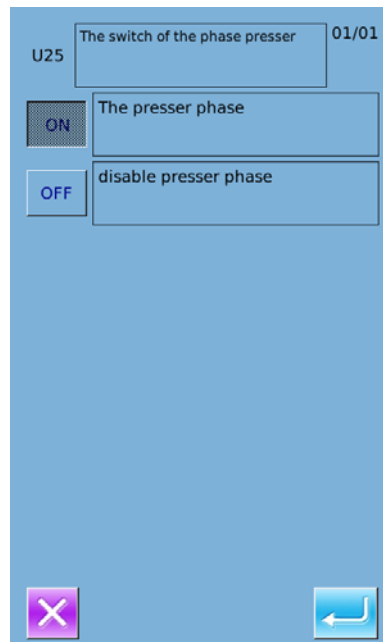

Select U25 and enter the interface below



**② Parameter Encryption**

A、 Press “Encryption” to enter the password input interface.

Press  to clear all the content

Press  to erase one figure at each pressing

B、 Input the right password to enter the interface for parameter encryption

Select the parameter for encryption

Press **【Select All】** to attach password to all the parameters

Press **【Reverse】** to select parameter for encryption in reverse way

Press**【Change】** to change the password, the default is the manufacturer ID

Press  to quit the encrypting function

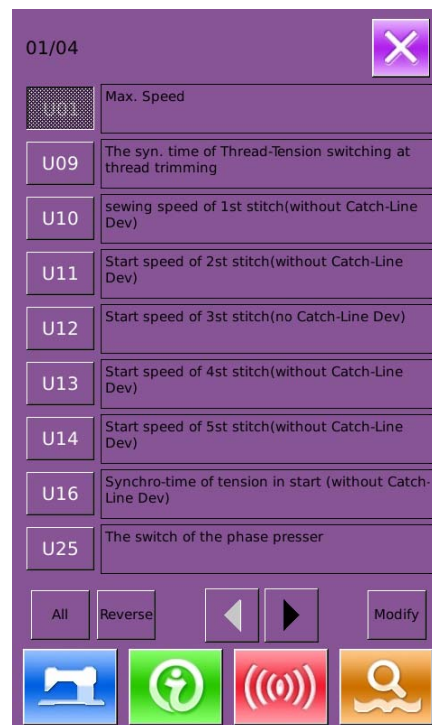
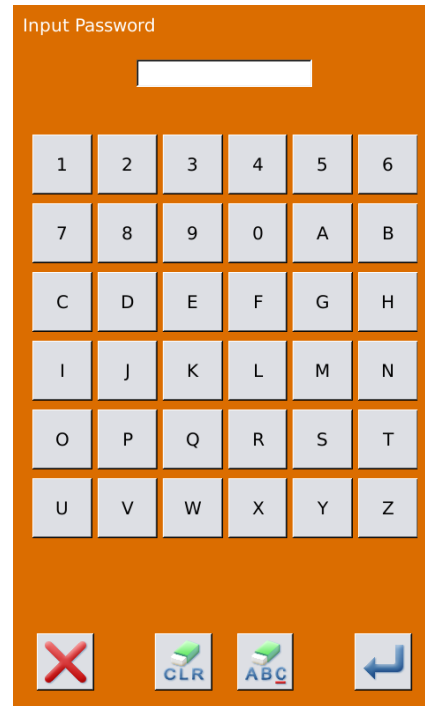

### ③ Check the changed parameter

- A、 When parameter is changed, the system will display “Modified” key at parameter setting interface.
- B、 In the parameter setting interface, press **【Modified】** to check the changed parameters.  
At first, the system will ask user to input the password. For the operation at password input interface, please refer to the “A” at ②. After inputting the right password, user can enter the interface for inquiring changed parameters.
- C、 Under the interface of changed parameter inquiry, user can find the list containing all the changed parameters with their current value and default value.

In that interface:

- Press **【All Rest】** will restore all the changed parameters to their default values
- Click Parameter Name, like **【Presser Type】** and then press **【Select Rest.】** to restore this parameter to the default value. User can select many parameters at here.
- Press Parameter Number, like **【U14】** to enter the parameter setting interface, where user can reset the parameter value.
- When the pages are more than one, user can use arrow key to turn the page
- Press  to quit the interface.

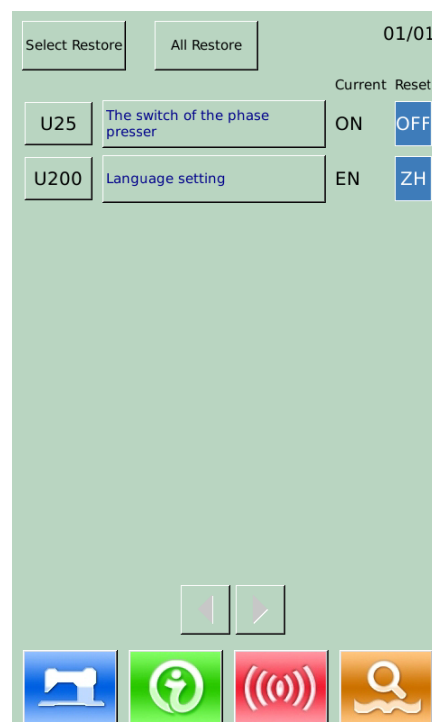
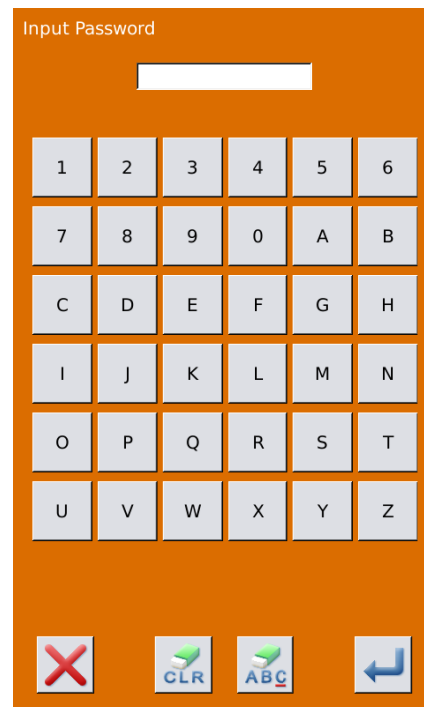

## ④ List of Level 1 Parameters

No.	Parameter	Range	Unit	Default value
U01	Max Sewing Speed	400~3000	100rpm	2700rpm
U02	Start Speed of 1 <sup>st</sup> Stitch (with thread-catching function)	400~1500	100rpm	1500rpm
U03	Start Speed of 2 <sup>nd</sup> Stitch (with thread-catching function)	400~3000	100rpm	3000rpm
U04	Start Speed of 3 <sup>rd</sup> Stitch (with thread-catching function)	400~3000	100rpm	3000rpm
U05	Start Speed of 4 <sup>th</sup> Stitch (with thread-catching function)	400~3000	100rpm	3000rpm
U06	Start Speed of 5 <sup>th</sup> Stitch (with thread-catching function)	400~3000	100rpm	3000rpm
U07	Thread Tension of 1st Stitch (with thread-catching function)	0~200	1	200
U08	Thread-tension at Thread-trimming	0~200	1	0
U09	Thread Tension Changeover Timing at Thread-trimming	-6~4	1	0
U10	Start Speed of 1 <sup>st</sup> Stitch	400~1500rpm	100rpm	400rpm
U11	Start Speed of 2 <sup>nd</sup> Stitch	400~3000rpm	100rpm	900rpm
U12	Start Speed of 3 <sup>rd</sup> Stitch	400~3000rpm	100rpm	2700rpm
U13	Start Speed of 4 <sup>th</sup> Stitch	400~3000rpm	100rpm	2700rpm
U14	Start Speed of 5 <sup>th</sup> Stitch	400~3000rpm	100rpm	2700rpm
U15	Thread Tension of 1st Stitch (No thread-catching function)	0~200	1	0
U16	Thread Tension Changeover Phase at Sewing Start	-5~2	1	-5
U25	Presser Height Division Switch ON: Permit Presser Height Division OFF: Forbid Presser Height Division	0: Permit Presser Height Division 1: Forbid Presser Height Division	1	1
U26	Adjustment of Divided Presser Height at 2 Levels' Stroke	50~90	1	70
U27	Counting Unit of the Sewing Counter	1~30	1	1

No.	Parameter	Range	Unit	Default value
U31	Stop Sewing Machine with Button on Panel OFF: Invalidity PANEL: Pause Key at Panel EXT: External Switch	0: Invalidity 1: Pause Key at Panel 2: External Switch	1	1
U32	Settings on Buzzer Sound OFF: Silence PAN: Operating Sound ALL: Operating Sound + Alarm	0: Silence 1: Operating Sound 2: Operating Sound + Alarm		2
U33	Number of Releasing Stitch at Thread-catching	1~7	1	2
U34	Display Phase at Thread-catching	-10~0	1	-5
U35	Thread-catching Switch ON: Permit OFF: Forbid	0: Permit 1: Forbid	1	1
U36	Select Time for Feeding Actions	-8~16	1	12
U37	Presser Status at Sewing End 0: Return and then lift presser 1: Lift presser and then return 2: step the pedal first and then lift the presser	0: Return and then lift presser 1: Lift presser and then return	1	1
U38	Presser Goes Up at Sewing End ON: Presser Up Permitted. OFF: Presser Up Forbidden	0: Presser Up Permitted. 1: Presser Up Forbidden.	1	0
U39	Whether to search origin after sewing (combination sewing not included) OFF: Not Search ON: Search	0: Not Search 1: Search	1	0
U40	Origin-Searching at Sewing Combination Patterns	0: Not Search	1	0

No.	Parameter	Range	Unit	Default value
	OFF: Not Search Origin PAT: Search Origin at Finishing Each Pattern CLC: Search Origin at Finishing Each Cycle	Origin 1: Search Origin at Finishing Each Pattern 2: Search Origin at Finishing Each Cycle		
U41	Search Origin at Shifting P Pattern OFF: Invalid ON: Valid	0: Invalid 1: Valid		0
U42	Needle Rod Stop Position UP: Upper Position DEAD: Highest Point	0: Upper Position 1: Highest Point	1	0
U46	Permit Trimming the Thread ON: Permit OFF: Forbid	0: Permit 1: Forbid	1	0
U49	Winding Speed Setting	800~2000	100rpm	1600rpm
U64	Select Unit for Size Change %: Input Percentage SIZ: Input Actual Size	0: Input Percentage 1: Input Actual Size		0
U88	Scale Mode OFF: Forbidden PIT: Change at Stitch Pitch STI: Change at Stitch Number	0: Forbidden 1: Changes at Stitch Pitch 2: Changes at Stitch Number		1
U97	Thread-trimming Method after Pause AUT: Automatic	0: Automatic 1: Manual	1	0

No.	Parameter	Range	Unit	Default value
	MAN: Manual			
U135	Return to Start Point or Origin at Sewing End 0: Start Point 1: Origin	0: Start Point 1: Origin	1	0
U190	Back Light Auto Off OFF: Not Auto Off ON: Auto Off	OFF : Not Auto Off ON: Auto Off		0
U191	Back Light Off Wait Time	1~9	1m	3m
U192	Back Light Adjustment	20~100		100
U193	Modify the Counter Value OFF: Permit ON: Forbid	0: Permit 1: Forbid		0
U194	Operation at Reaching set value of Counter OFF: Stop Sewing ON: Continue Sewing	OFF: Stop Sewing ON : Continue Sewing		0
U195	Voice Column	30~63		50
U200	Language 0: Chinese 1: English	0: Chinese 1: English		0
U201	Set Language at Power-on OFF: No ON: Yes	OFF: No ON: Yes		0
U212	Presser Down Order at Separating Valves 0: Same Time 1: Left then Right 2: Right then Left	0: Same Time 1: Left then Right 2: Right then Left		0
U213	Presser Up Order at Separating Valves 0: Same Time	0: Same Time 1: Left then Right		0



No.	Parameter	Range	Unit	Default value
	1: Left then Right 2: Right then left	2: Right then Left		
U214	Reverse Presser OFF: Forbid ON: Enable	OFF: Forbid ON: Enable		1

### 8.3 Level 2 Parameters Setting

#### ① Parameter Setting

At Mode Setting Level 3 Interface, press



to have access to Level 2 Parameter

Setting Interface (as shown in right picture).

For the operation methods, please refer to descriptions at 8.2 Level 1 Parameters Setting.

When some parameters are changed, the system will display the “Modified” in the parameter setting interface.



Press to quit the setting interface



② Parameter Encryption

For the operations, please refer to the description within “8.2 Level 1 Parameters Setting”

Press  to quit parameter encryption interface

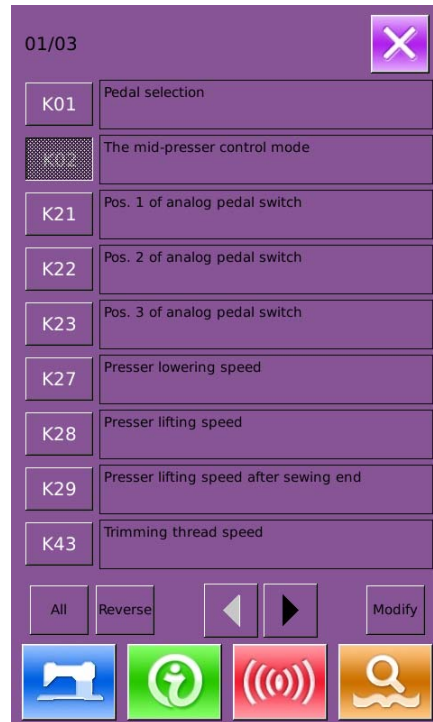

③ Check the changed parameters

When parameter is changed, the system will display “Modified” key at parameter setting interface

In the parameter setting interface, press **【Modified】** to check the changed parameters. User can also reset the parameters here.

For the specific operation, please refer to “8.2 Level 1 Parameter Setting”

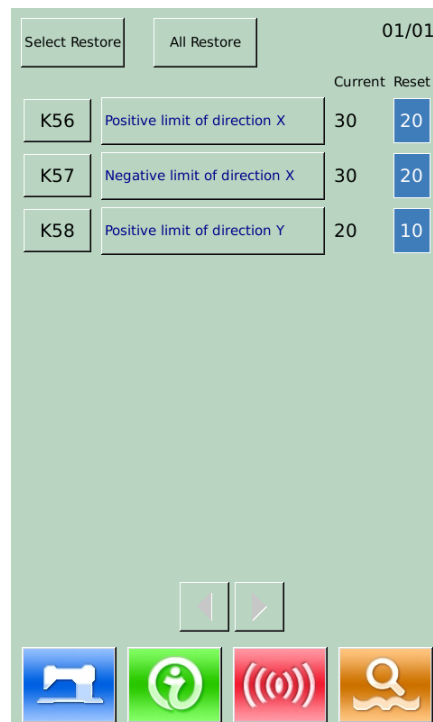

## ④ List of Level 2 Parameters

No.	Parameters	Range	Unit	Default
K01	Pedal Selection 0: Simulate 2: Double Pedals 3: Double Pedals, only the operation pedal can control machine	0: Simulate 2: Double Pedals 3: Double Pedals, only the operation pedal can control machine	1	0
K02	Presser Control 0: No Presser Control 2: Presser Controlled by Solenoid 3: Presser Controlled by Mechanism	0: No Presser Control 2 : Presser Controlled by Solenoid 3 : Presser Controlled by Mechanism		0
K19	Presser Up Time	0~50 (For air valve only)	5	30
K21	Simulated Pedal Position 1	50~200	1	70
K22	Simulated Pedal Position 2	50~200	1	120
K23	Simulated Pedal Position 3	50~200	1	185
K27	Speed for Lowering Presser	100~4000pps	10pps	4000pps
K28	Speed for lifting Presser	100~4000pps	10pps	1500pps
K29	Speed for Lifting Presser at Sewing End	100~4000pps	10pps	3000pps
K43	Trimming Speed	300~700rpm	100rpm	400rpm
K44	Empty Feeding Control At Thread-trimming OFF: Ineffective ON: Effective	OFF: Ineffective ON: Effective	1	1
K45	Needle Guider Diagram at Controlling Empty Feeding	1.6~4.0mm	0.2mm	1.6mm

No.	Parameters	Range	Unit	Default
K56	Move Range +X Direction	0~50mm	1mm	20mm
K57	Move Range -X Direction	0~50mm	1mm	20mm
K58	Move Range + Y Direction	0~30mm	1mm	10mm
K59	Move Range -Y Direction	0~30mm	1mm	20mm
K64	Thread-stirring Method 0: By Solenoid 1: By Motor	0: By Solenoid 1: By Motor	1	1
K66	Number of pulse at Stirring Operation with Presser Linkage	30~60	1	45
K74	Selection of Solenoid/ Air-driven Presser AIR: Air-driven Presser MOTO: Motor Presser	AIR: Air-driven Presser MOTO: Motor Presser	1	1
K95	Trimming Angle	-10~10	1	0
K112	Stop Position Compensation	-10~10	1	0
K122	OC	-128~128	2	0
K123	OD	-128~128	2	0
K124	BD	-512~512	4	0
K125	OC	184.5~244.5	0.1	208
K126	OD	144.6~204.6	0.1	174
K127	BD	39~59	0.1	53
K128	Stepping Control Method	0: DSP1 Close Loop, DSP2 Close Loop 1: DSP1 Opean Loop, DSP2 Close Loop 2: DSP1 Close Loop, DSP2 Opean Loop 3: DSP1 Opean Loop, DSP2 Opean Loop	0~3	1

No.	Parameters	Range	Unit	Default
K135	Solenoid Junction Delay	-10~30		
K137	Solenoid Thread-catching Angular Deflection	-150~150		
K138	Solenoid Suction Delay	-1~1		
K140	Thread Tension Control Method 0: Electronic Method 1: Mechanical Method	0: Electronic Method 1: Mechanical Method		
K141	Adjustment of Close Force at Branch Tension Solenoid	-20~20		
K142	Adjustment of Holding Force at Branch Tension Solenoid	-40~40	1	0
K144	Motor Thread-separating Delay (For Fang Zheng Only)	-15~15	1	0
K145	Motor Thread-trimming Delay (For Fang Zheng Only)	-10~10	1	0
K150	Head Safety Switch ON: Normal OFF: Forbid	ON: Normal OFF: Forbid		0
K200	Restore Default Settings			
K241	Type Setting Note: At changing the machine type, the system will re-add the basic patterns and delete the saved normal patterns	0: Bar-tacking Machine 5: 1906 Machine 7: Button Sewing Machine		0

## 8. 4 Counter Setting

Press  to have access to the Counter Setting Interface (as shown in right picture).

Procedure:

### ① Counter Selection

Select Sewing Counter or No.of Pcs Counter

### ② Set the Current Value and the Set Value of Counter

At the set type, press the “Current” or “Setting” to perform the relating operation.

### ③ Select Up Counter or Down Counter

At the selected type, please press “Up” and “Down” to perform the relating operations

Press  to quit counter setting interface

Press  to finish setting and quit.

### Sewing UP Counter :

Every time the sewing of one shape is performed, the existing value is counted up 1. When the existing value is equal to the set value, the interface of counter exceed warning will be displayed. Press

 to restore the existing value to 0

### Sewing DOWN Counter:

Every time the sewing of one shape is performed, the existing value is counted down 1. When the existing value is reached to "0", the interface of counter exceed warning will be displayed. Press

 to restore the existing value to the set value.

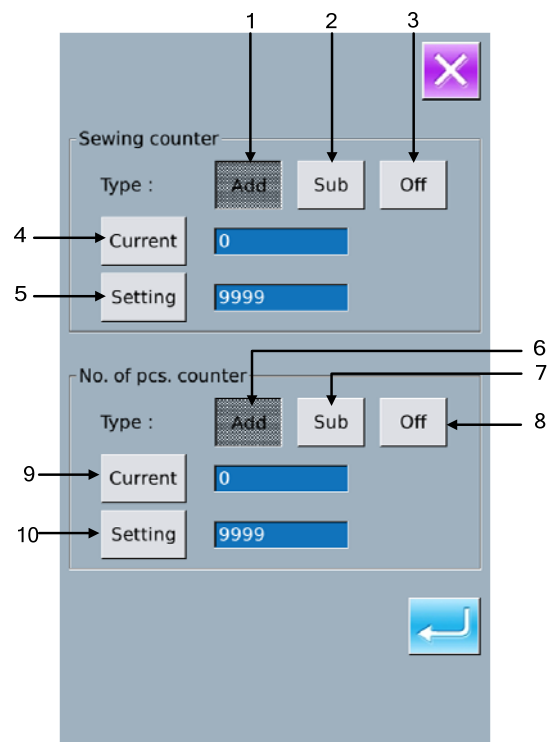

**No of piece UP counter:**

Every time a cyclic sewing or a continuous sewing is performed, the existing value is counted up 1. When the existing value is equal to the set value, the interface of counter exceed warning will be displayed. Press  to restore the existing value to 0

**No of piece DOWN counter:**

Every time a cyclic sewing or a continuous sewing is performed, the existing value is counted down 1. When the existing value is reached to "0", the interface of counter exceed warning will be displayed. Press  to restore the existing value to the set value.

**④ Turn Off Counter**

At the selected counter type, press "Off" to turn off the counter.

**8. 4. 1 Functions**

No.	Function
1	Sewing Add Counter
2	Sewing Down Counter
3	Sewing Counter Off
4	Set Current Sewing Counter Value
5	Set the Setting Value of Sewing Counter
6	No.of Pcs Add Counter
7	No.of Pcs Down Counter
8	No.of Pcs Counter Off
9	Set Current No.of Pcs Counter Value
10	Set the Setting Value of No.of Pcs Counter

## 8. 5 Change Sewing Mode



Press  to enter the interface of sewing type selection



: Normal Sewing



: Cyclic Sewing

After confirming the sewing type, press



to end the operation. Press , then the data input interface of the selected sewing type is displayed.



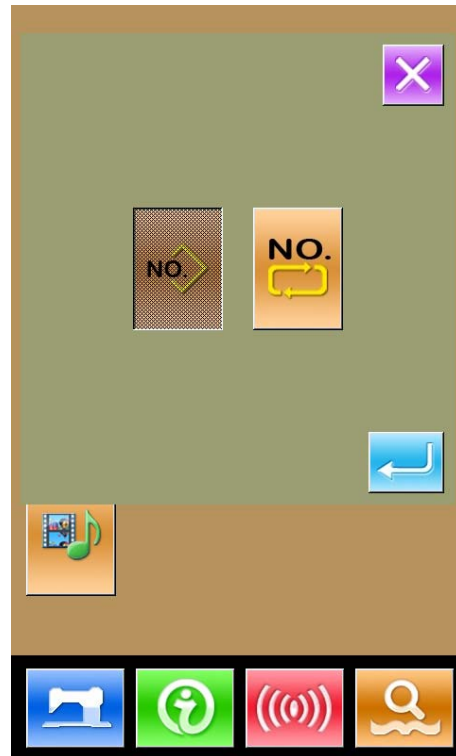

Press  to quit and the original sewing type remains.





### 8.6 Have Access to Pattern Edition

Press  to shift between the following two figures. Select the corresponding mode and press  to enter the pattern edition mode (Please refer to section 5.1)

 : Sewing Mode

 : Edition Mode



### 8.7 Set Pattern Lock

In Setting Mode Level 1, press  to enter the interface for setting pattern lock, where the entire pattern number will be displayed. 32 pattern numbers are in each page. For locking a pattern, user only needs to press the pattern number. The selected pattern number will be displayed in dark.

Press  to save the setting. The selected patterns will be locked.



## 8.8 Initialization

Press  to enter the interface for setting the keyboard lock.

In this interface, user can operate:

- U Disk Initialization
- Memory Initialization
- Customized Initialization
- P and C Pattern Initialization

Press the relating functions keys and enter the corresponding interface.

Press  to quit.

### ① Press “USB” to Initialize U Disk Files

Press  to initialize all the U disk files

Press  to quit U disk initialization

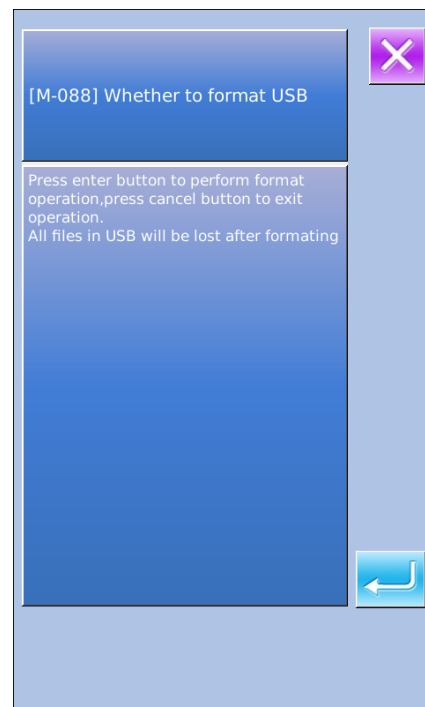
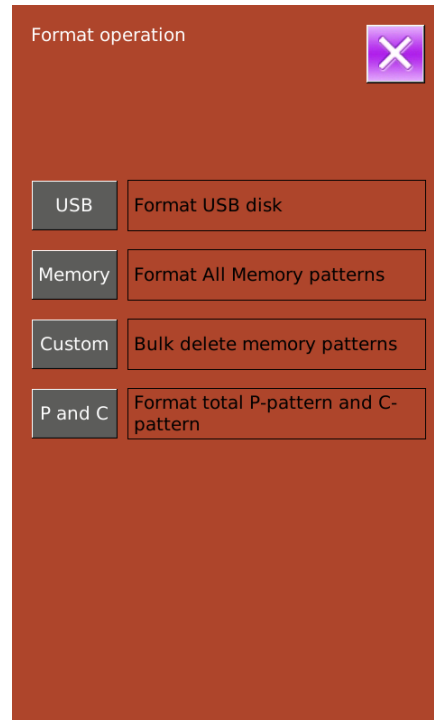

## ② Press “Memory” to initialize memory patterns

The following patterns can be initialized:

- Normal Pattern (Basic Patterns & User Patterns)
- Cyclic Sewing Pattern
- Registered P Pattern

Press  to initialize all the files in memory

Press  to quit

**※Caution! This operation will delete all the patterns within the memory!**



## ③ Press “Custom” to perform the batch deletion

In this interface, the system will display all the pattern files within the memory. Click the corresponding button to perform the batch deletion.

Operations at this function:

A. Use “Up Arrow”, “Down Arrow” to turn the page

B. Use the following three operations to select patterns

- a) Press  to select all the patterns
- b) Press  to select pattern in contrary way
- c) Input pattern number

C. Press  to delete the patterns in batch

D. Press  to quit Initialization

Interface

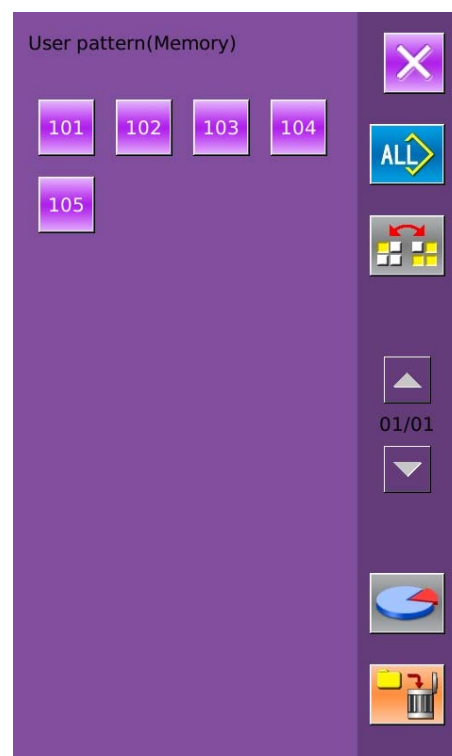
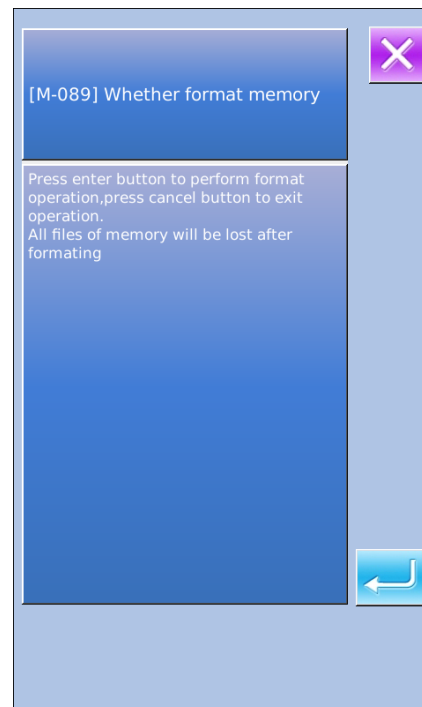

#### ④ Under the Interface of Custom

Initialization, press  to display the free room of the memory and the number of patterns in each format.

Press  to return to the upper interface.

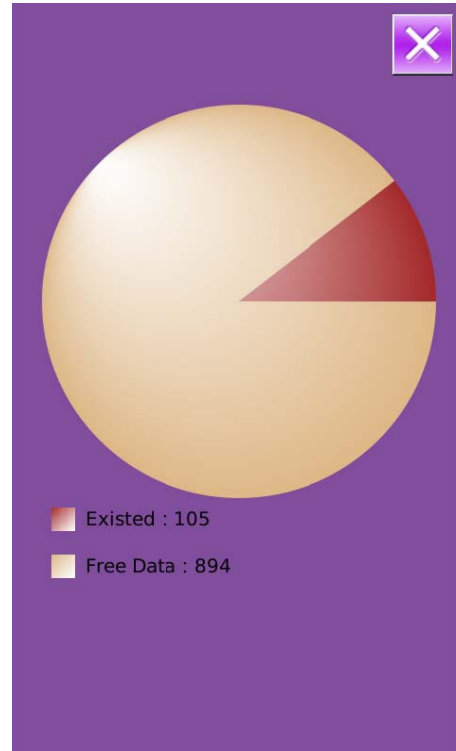

## 8.9 Software Version Inquiry

At Mode Setting Level 2 Interface, user can

press  to check the software version of system.

 : Save the Current version information to the root directory of U disk.



A software version inquiry screen with a close button (X icon) in the top right corner. It lists various version numbers in text boxes:

- Panel Ver. : SC203-KD-JK-v1.0.86
- Main-Control Ver. : \*\*\*\*\*MC-A-
- Main-Motor Ver. : \*\*\*\*\*MM-A-
- Step-Motor-1 Ver. : \*\*\*\*\*MD-A-
- Step-Motor-2 Ver. : \*\*\*\*\*MD-A-
- Fs Ver. : SC203-FS-JK-v1.0.1
- Os Ver. : SC203-OS-JK-v1.0.1
- Compiling Time : 2013-06-19

A save icon (gears and floppy disk) is located in the bottom right corner.

### 8. 10 Test Mode



At Mode Setting Level 2 Interface, user can press to have access to the Test Mode Interface (as shown in right picture)

The following is the list of each figure

No.	Name
A	I01 Touching Panel Correction
B	I02 LCD Test
C	I03 Input Test
D	I04 Speed Test
E	I05 Output Test
F	I06 Continuous Running
G	I07 XY Motor Origin Test
H	I09 Presser-/ Origin Sensor Test
I	Thread-catching Motor/ Origin Sensor Test

Press  to quit the Test Mode interface

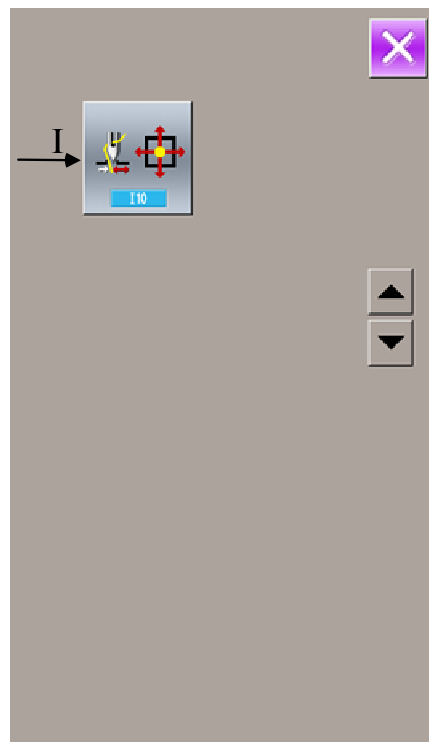
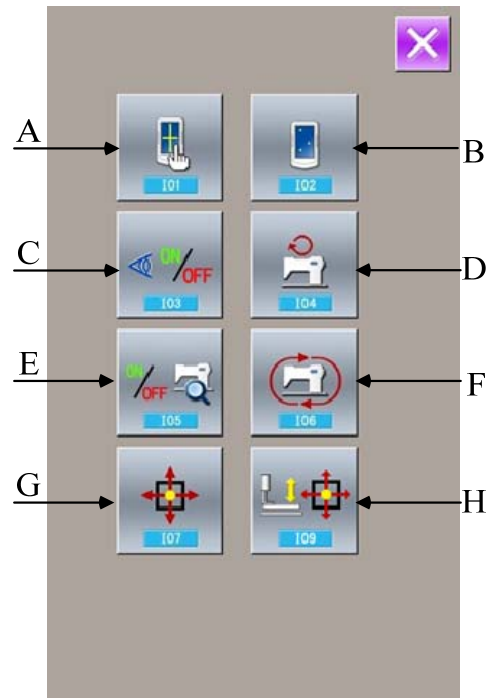

## (1) Correction of Touching Panel

A、 In the interface of Mode Inspection, Press



(I01 Correction of Touch Panel). Then system will hint user 【 Enter Touching Panel

Correction Mode?】 . Press  to enter the interface for Touch Panel Correction (as shown

in right figure). Press  to quit the correction status.

B、 Because the corrections for five spots are needed, the user had better click the cross icon on the screen with tools like touching pen. After the correction, the system will tell user that this operation is successful or not.

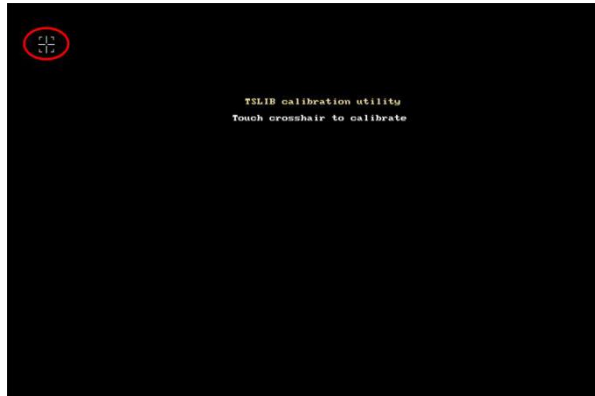

※**During the correction, please do perform the operation according to the positions of crosses. Otherwise, the touching panel will be unable to work normally after the correction.**

## (2) Inspection of LCD Display



In the interface of Mode Inspection, press (I02 Inspection of LCD Display) to enter the interface of LCD Display Inspection (as shown in right figure). Check whether the LCD fades in that status.

Touch the panel to have the screen display in the cycle of “Blue — Black — Red — Green — White”.

Press  to quit the interface of LCD Display Inspection



## (3) Input Signal Test Method



In the interface of Test Mode, press (I03 Input Inspection) to enter the interface of input inspection interface (as shown in right). Users can confirm the input status of each switch and sensor.

**ON:** Turn On

**OFF:** Turn Off

01: Start Switch

02: Presser Switch

03: Analog Pedal

04: X Motor Sensor

05: Y Motor Sensor

06: Origin Sensor of Outside-presser Motor

07: Sensor of Head Reversion

08: Sensor of Thread-trimming Motor

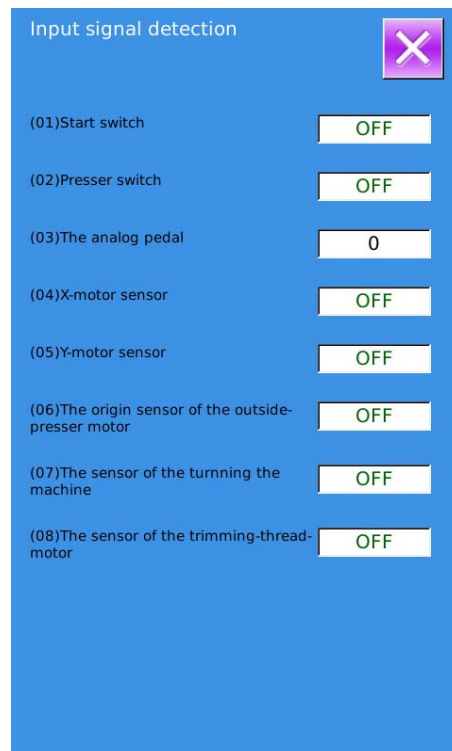

## (4) Speed Test

### ①Interface for Speed Test

In the interface of Mode Inspection, Press  (I04speed test) to enter the interface for Speed Test (as shown in right figure). The speed of main shaft motor can be tested in that interface.

Press  to quit the interface for speed test.

### ②Speed Test Setting

Press “+” & “-“ to set the speed of the main shaft motor.

Press , then the motor will run at the set speed. At this moment, the actual tested speed is displayed

in the interface.. Press  to stop the machine

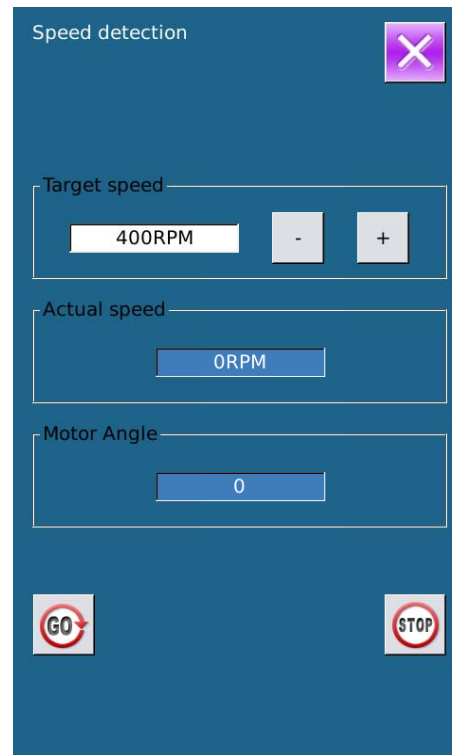

## (5) Output Inspection

In the interface of Mode Inspection, Press  (I05 Output Inspection) to enter the interface of Output Inspection (as shown in the right figure). The following output status of the solenoid can be checked under that interface.

01: Thread-releasing Solenoid Test

02: Needle Thread Solenoid Test

Press  to quit output inspection interface

※**Attention: Sewing machine will perform relating actions.**

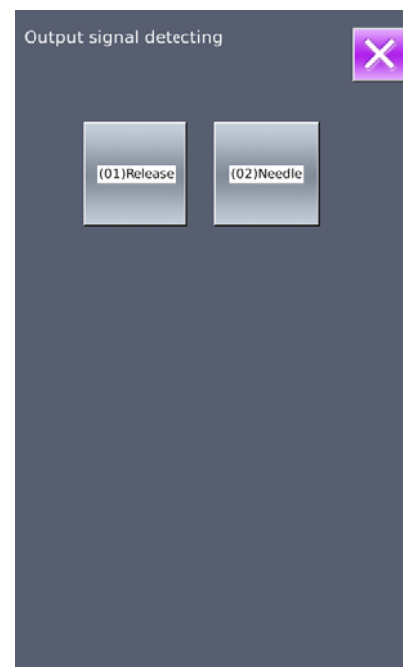



## (6) Continuous Running

### ①Display the interface for continuous running

In the interface of Mode Inspection, Press  (I06continuous running) to enter the interface of continuousrunning (as shown in right figure).

A: Action interval

B: Origin Detection

Press  to quit that interface.

### ②Continuous running setting

Click the columns under the interface of Continuous Running to set the Action interval and Origin Detection. Set the value with the number keys.

Press  and step the pedal to start the continuous running. During the running, user can use the pause switch to stop machine or he can stop machine by stepping the pedal or pressing pause switch at action end

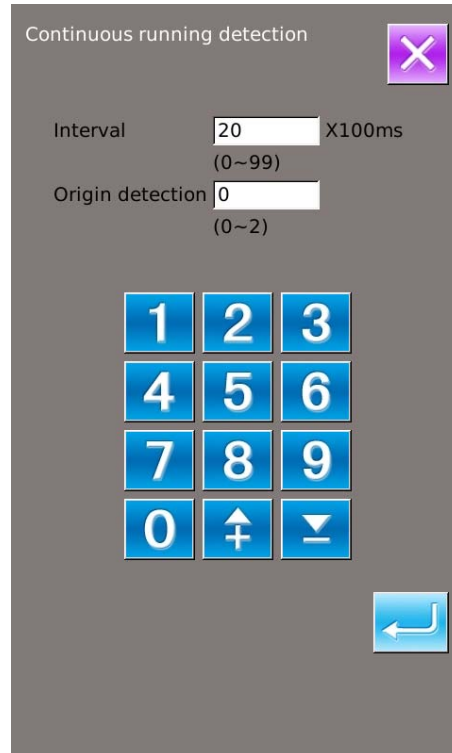



## (7) XY Motor Origin Sensor Test

At Test Mode Interface, user can press  (I07XY Motor Origin Test) to activate XY Motor/Origin Output Test Interface (as shown in right picture). If user turns on the machine without

entering the Ready Status and pressing  to search the origin, user can directly press the direction keys to move the motor and display the On/Off statuses of Sensors at both XY sides. In this way, user can test the working condition of the XY Motor Driver and their sensors. If user enters the Ready

Status after power-on or presses  to search

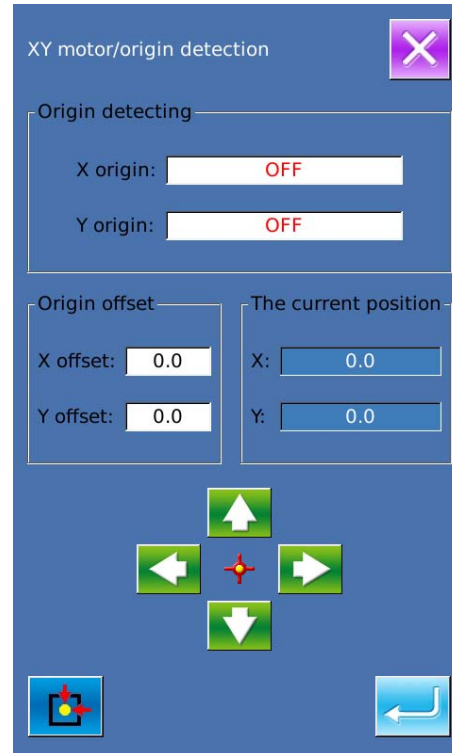

origin, the user will have to press  to search origin at each entry to the I07 mode in future so that he could use direction keys to move XY motors. This is the manual adjustment of the XY origin. The coordinates displayed at left is the deviation value of the origin, while the coordinates displayed at right is the current position of presser frame. User can press

 to set current position as the reference value of the origin.



### (8) Presser Motor / Origin Sensor Detection

According to the status of the presser origin sensor, the position A displays the status (ON/OFF) of presser origin sensor; position B displays the status of trimming sensor.

By using  & , the user can drive the presser motor at each pulse

Additionally, pressing  is to drive presser motor to the position pointed at below, whose figure is displayed in dark.

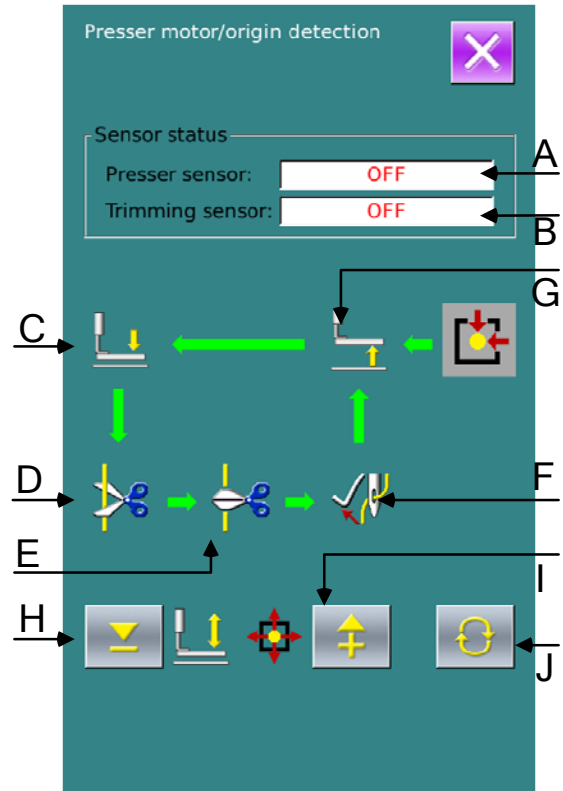

A: Presser Sensor B: Trimming Sensor

C: Presser down Position

D: Thread-trimming Wait Position

E: Trimming Finish Position

F: Thread-stirring Position

G: Presser Up Position

H: Forward one Step

J: Move to Next Position



I: Backward one Step

**Note: Use Switch to search the origin of presser & thread-trimming motor, then this function will be effective.**

**(9) Thread-catching Motor/ Origin Sensor**

**Detection**

According to the status of the presser origin sensor, the position A displays the status (ON/OFF) of thread-catching sensor; position B displays the status of thread-catching sensor.

By using  & , the user can drive the motor at each pulse

Additionally, pressing  is to drive thread-catching motor to the position pointed at below, whose figure is displayed in dark.

A: Catching Sensor B: Origin Sensor

G: Holding Position

C: Waiting Position

D: Catching Position

F: Release Position

H: Forward one Step

I: Backward one Step

J: Move to Next Position

**Note :** Use Switch to search the origin of thread-catching motor, then this function will be effective.

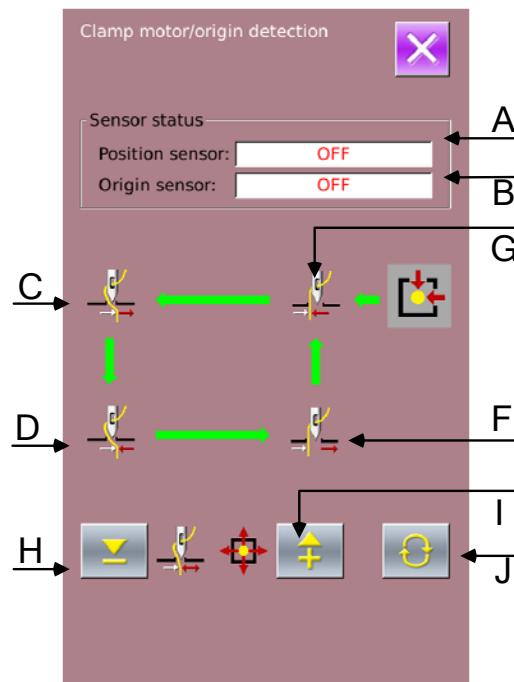

## 8.11 Keyboard Lock

At Setting Mode Level 2 Interface, user can



press  to activate Keyboard Lock Setting Interface.

### ①Operation for Keyboard Lock





: Keyboard Unlocked



: Keyboard Locked



Select  and then  to finish the operation of locking keyboard. Press  to quit the keyboard lock operation.

### ②Display of Keyboard Lock Status

Close Parameter Setting Mode Interface, and have system return to Sewing Data Input Interface (as shown in right picture.),

where user can see a lock figure  under the pattern number. In the Keyboard Locked status, only the available figures can be displayed.

### ③Range of Keyboard Lock

1、Interface of Normal Sewing Data Input:

- 1) Pattern Registration
- 2) Pattern Naming
- 3) Scale Rate Setting
- 4) Max Speed Limitation

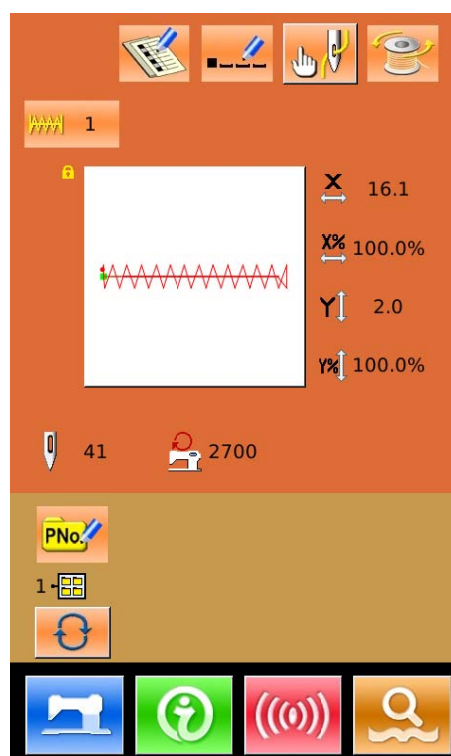
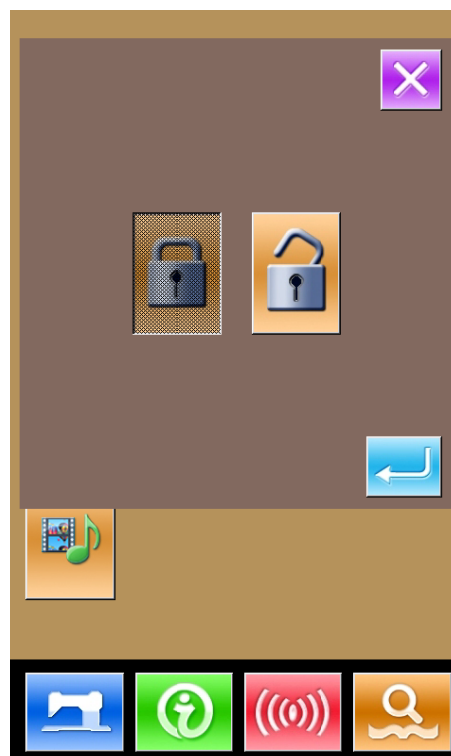

- 5) P Pattern Registration
- 6) Pattern Deletion
- 2、Normal Sewing Interface:
  - 1) Frame-moving
  - 2) Counter Setting
- 3、P Pattern Input Interface:
  - 1) P Pattern Edition
  - 2) P Pattern Copy
  - 3) P Pattern Naming
  - 4) Pattern Deletion
- 4、P Pattern Sewing Interface:
  - 1) Counter Setting
- 5、C Pattern Data Input Interface:
  - 1) C Patten Registration
  - 2) C Pattern Copy
  - 3) C Pattern Naming
  - 4) C Pattern Edition
  - 5) Pattern Deletion
- 6、C Pattern Sewing Interface:
  - 1) Counter Setting
- 7、parameter Setting Mode:
  - 1) Level 1 Parameter
  - 2) Level 2 Parameter
  - 3) Counter edition
  - 4) Test Mode
- 5): Pattern Lock Setting

## 8. 12 Parameter Back-up

In setting mode level 3, press  to enter the interface of parameter back-up & restoration, as shown in right:

**Clear:** Clear all the customized parameters that are saved.

**Save:** Save current parameters

**Restore:** Restore the current parameters

① Click any key among  ~

 to set the position for

saving the parameter. And then press 「Save」 to save that parameter.

② Check the content on 「Custom xx (On/Off)」. If 「On」 is displayed in bracket, that means this position has the user parameter,

for an example .

③ Select the button with parameters, press 「Restore」 to reload the corresponding parameter values

④ Press 「Clear」 to delete all the saved parameters

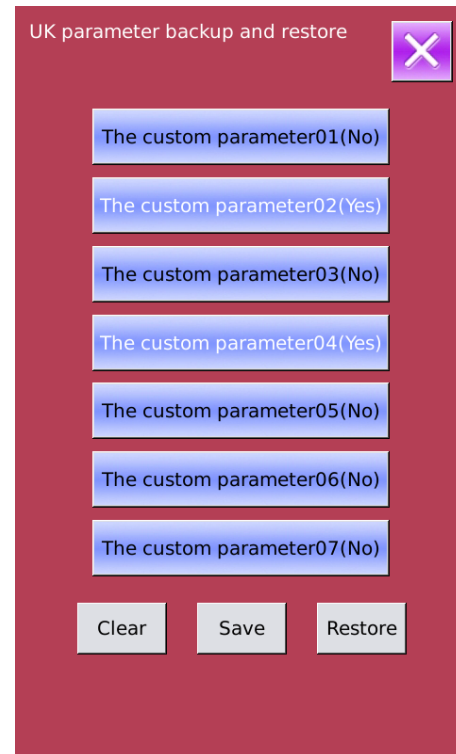

### 8.13 Button-stitching Function Setting

#### ①Parameter Setting Operation

At Setting mode Level 3 Interface, user can



press  to have access to Level 2 Parameter Setting Interface (as shown in right figure). For the operating methods, please refer to the descriptions in Level 1 or 2 Parameter Setting. Press Key **K241** to activate the next interface

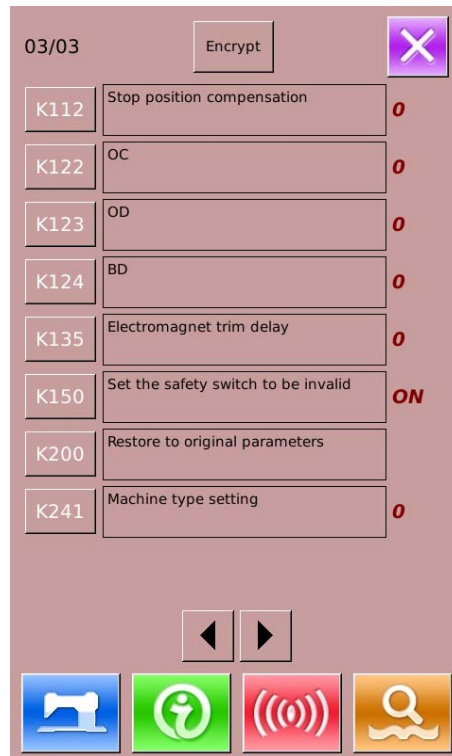

The right figure is the model selection interface. Press 7 to select button sewing function.

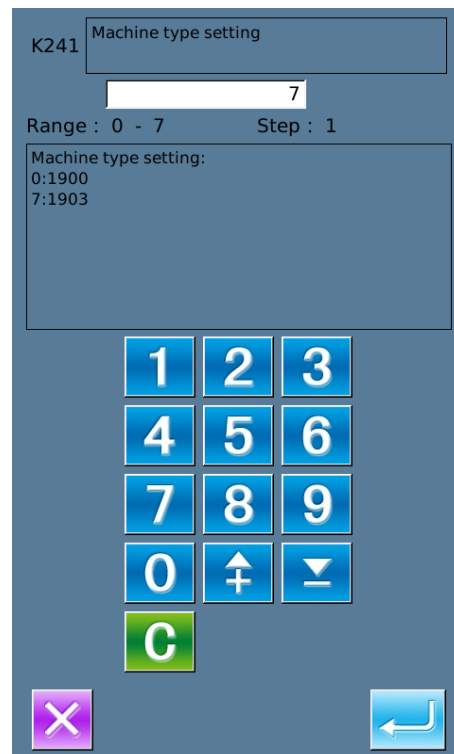

Press  to finish the selection.

**Note:** When the model is changed, the system will clear the entire saved pattern and reload the pattern for the newly selected model. Therefore, users have to pay attention to the back-up of patterns before changing the model.





At this moment, the Hint Interface will be displayed, as shown in right picture.

Pressing  is to cancel the settings, while pressing  is to confirm clearance of the existed patterns in the old model.

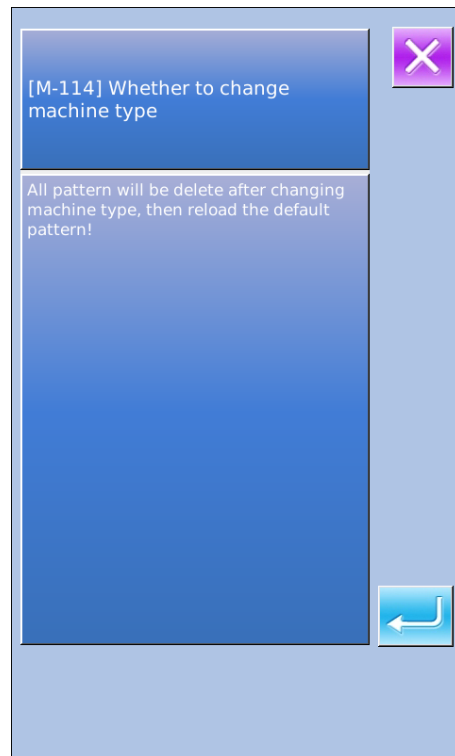

After clearing the pattern of old model, user has to turn off power, as shown in the right picture.

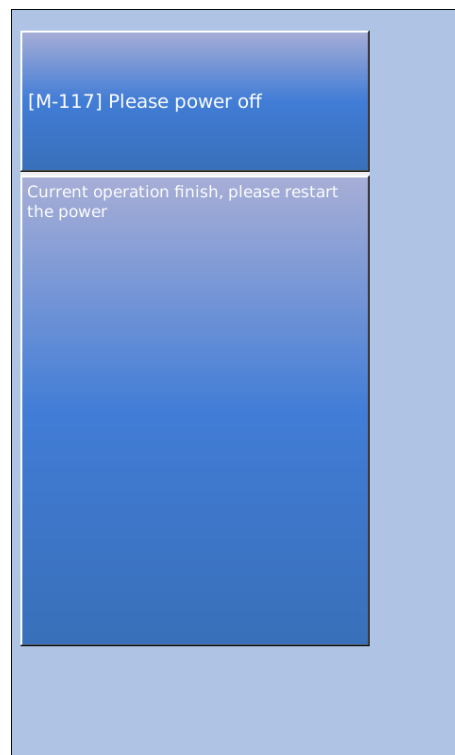

Re-power the machine. The hint interface for reloading patterns of new model will be displayed, as shown in the right picture.

The user only needs to press .

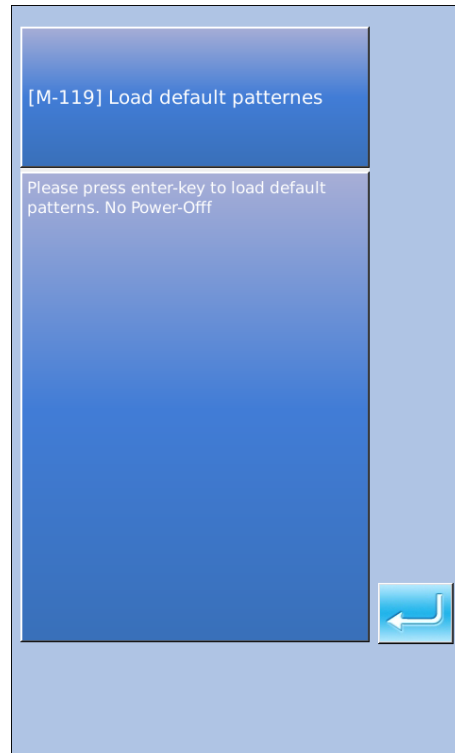

When loading the basic patterns for the new model successfully, the system will activate the Main Interface of Pattern N, as the right picture shows.

Button-sewingfunction is set successfully!



## 8.14 Pattern Edition Parameter Setting

At Setting Mode Level 3 Interface, user can



press  to activate the Interface for Setting Pattern Edition Parameters.

The figures of the available functions are displayed in dark, while the figures of the unavailable functions are displayed with highlight.

Edit the parameters according to your needs, press  to finish the setting.

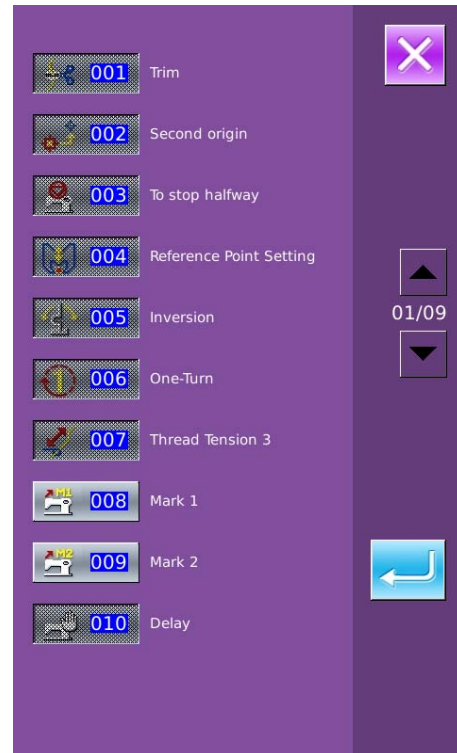

## 9 Controller System Principle

### 9.1 Structure of Control System

#### 9.1.1 Installation Size of Control Box

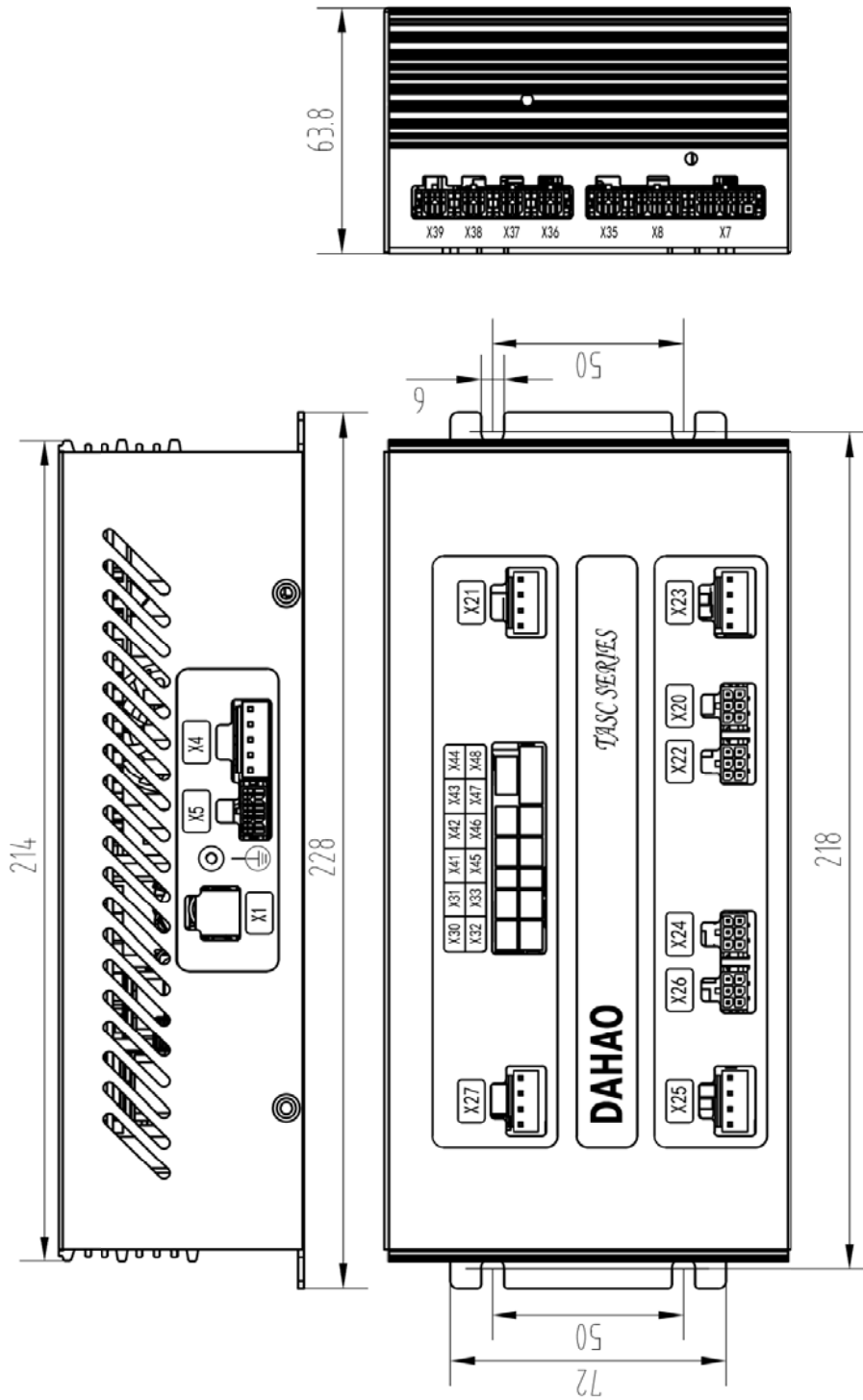

### 9.1.2 Installation Size of Operation Box

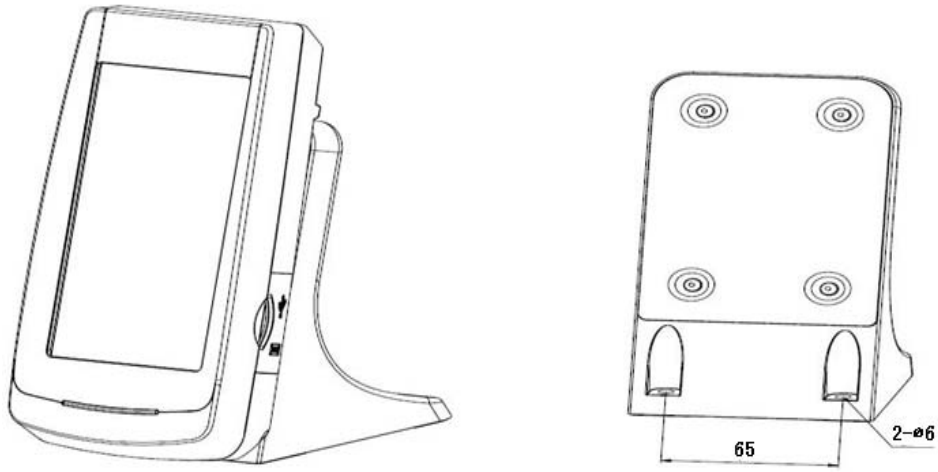





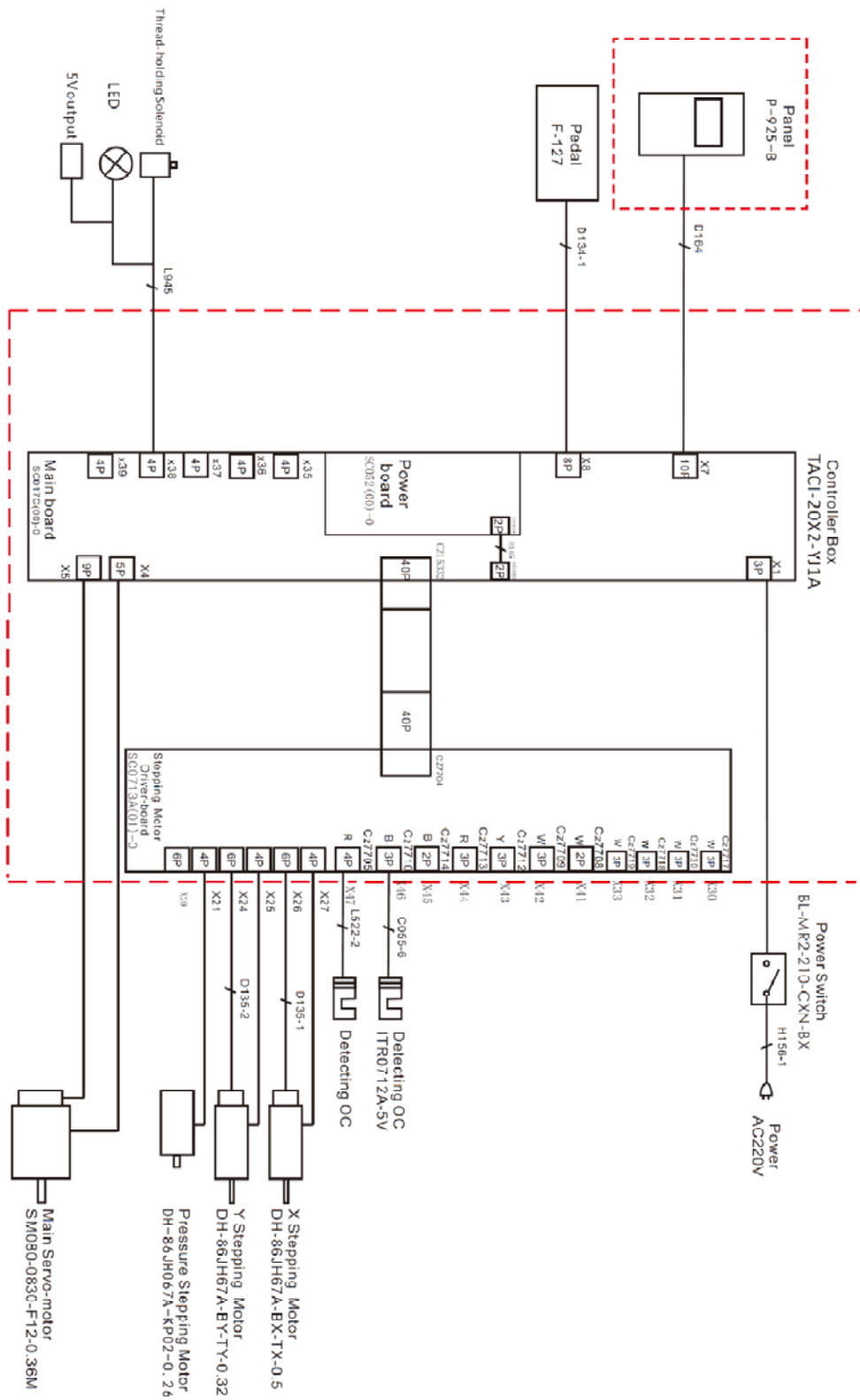



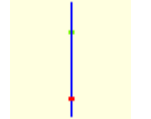
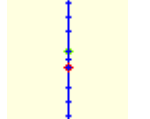
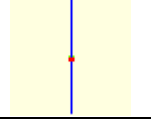
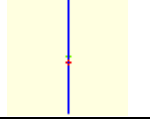

### 9.1.3 The Control System Diagram

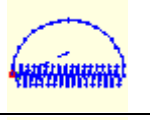
#### TASC201-2N/B



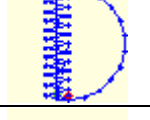
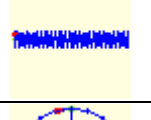
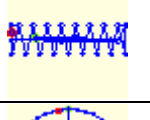
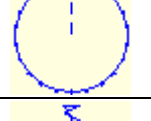
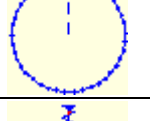
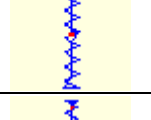
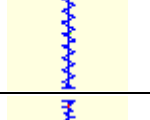
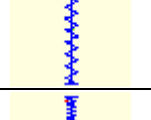
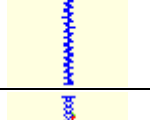
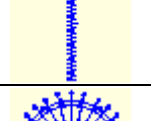
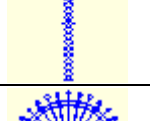
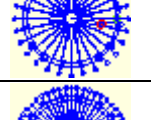
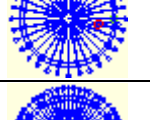
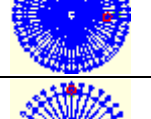
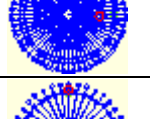
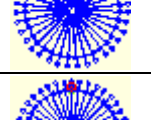







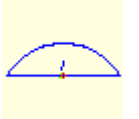
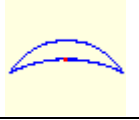
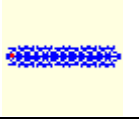

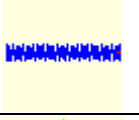

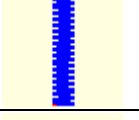

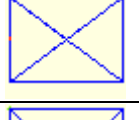
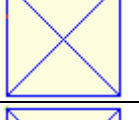
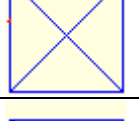
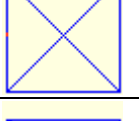



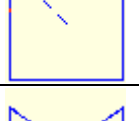
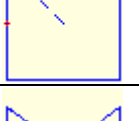
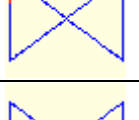

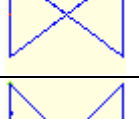
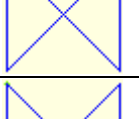
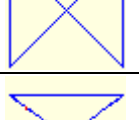
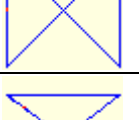
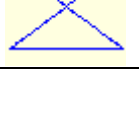
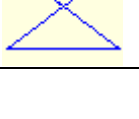







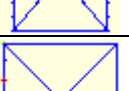

### 9.2 List of Patterns in 1900A Controller

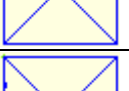
NO.	Patterns	Stitch Number	Length × Width (mm)	NO.	Pattern	Stitch Number	Length × Width (mm)
1		41	16.1×2	2		41	10.2×2
3		41	16×2.4	4		41	24×3
5		27	10.1×2	6		27	16×2.4
7		35	10.1×2	8		35	16×2.4
9		55	24×3	10		63	24×3
11		20	6.1×2.4	12		27	6.2×2.4
13		35	6.1×2.4	14		14	8×2
15		20	8×2	16		27	8×2
17		20	10×0	18		27	10×0
19		27	25.2×0	20		35	24.8×0
21		40	25.2×0	22		43	35×0
23		27	4×20	24		35	4×20
25		41	4×20	26		55	4×20

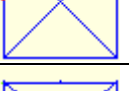































27		17	0×20	28		20	0×10
29		20	0×20	30		27	0×20
31		51	10.1×7	32		62	12.1×7
33		23	10.2×6	34		30	12×6
35		47	7×10	36		47	7×10
37		89	24×3	38		27	8×2
39		25	11.8×12	40		45	12×12
41		28	2.4×20	42		38	2.4×25
43		38	2.4×25	44		57	2.4×30
45		75	2.4×30	46		41	2.4×30
47		89	8×8	48		98	8×8
49		147	8×8	50		163	8×8
51		110	7.9×7.9	52		120	7.9×7.9
53		130	7.9×7.9	54		51	12.4×10.2



55		50	12.4×10.2	56		52	21×6
57		57	21×6	58		102	19×3
59		115	40×5	60		115	40×5
61		93	5×30	62		109	5×30
63		108	40×30	64		80	40×30
65		64	40×30	66		96	30×30
67		76	30×30	68		60	30×30
69		52	40×30	70		40	40×30
71		32	40×30	72		44	30×30
73		36	30×30	74		28	30×30
75		60	40×30	76		48	40×30
77		36	40×30	78		56	30×30
79		44	30×30	80		36	30×30
81		67	40×30	82		51	40×30









83		39	40×30	84		55	30×30
85		35	30×30	86		42	30×30
87		32	30.1×30	88		26	30×30
89		74	20×24	90		54	20×24
91		65	20×20	92		49	20×20
93		39	20×20	94		63	25×20
95		51	25×20	96		45	25×20
97		42	25×20	98		33	25×20
99		27	25×20	100		88	30×25

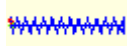

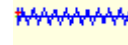



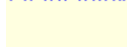
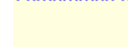

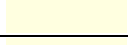
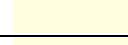
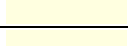
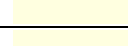
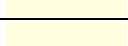
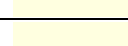
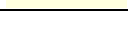
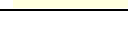

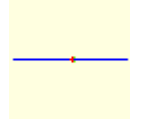
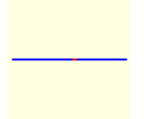
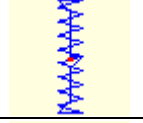
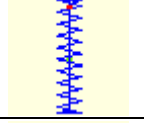
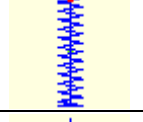
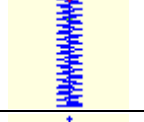
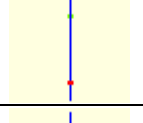
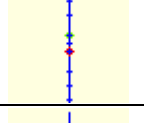
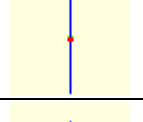
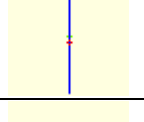
### 9.3 List of Patterns for Button-sewing in 1900B Controller

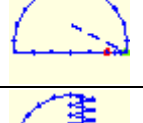
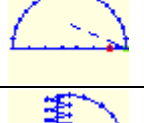

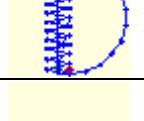
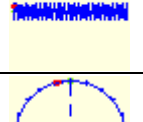
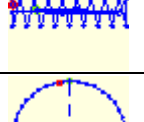
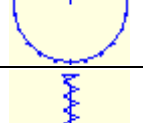
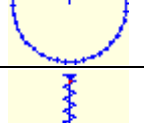
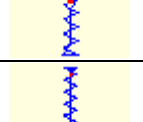
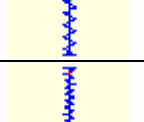
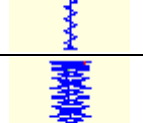

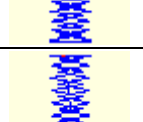





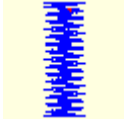
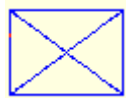
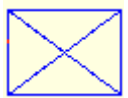



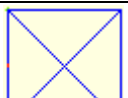

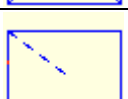
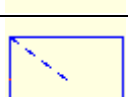
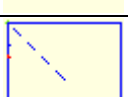

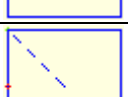
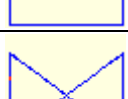
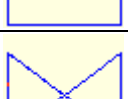
No.	Pattern	Thread Number	Standard Sewing Length X(mm)	Standard Sewing Length Y(mm)	No.	Pattern	Thread Number	Standard Sewing Length X(mm)	Standard Sewing Length Y(mm)		
1-34		6-6	3.4	3.4	18-44		6	3.4	0		
2-35		8-8			19-45		8				
3		10-10			20		10				
4		12-12			21		12				
5-36		6-6			22		16				
6-37		8-8			23-46		6			0	3.4
7		10-10			24		10				
8		12-12			25		12				
9-38		6-6			26-47		6-6	3.4	3.4		
10-39		8-8			27		10-10				
11		10-10			28-48		6-6				
12-40		6-6			29		10-10				
13-41		8-8			30-49		5-5-5			3.0	2.5
14		10-10			31		8-8-8				
15-42		6-6			32-50		5-5-5				
16-43		8-8			33		8-8-8				





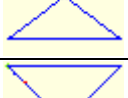

No.	Pattern	Thread Number	Standard Sewing Length X(mm)	Standard Sewing Length Y(mm)	No.	Pattern	Thread Number	Standard Sewing Length X(mm)	Standard Sewing Length Y(mm)
17		10-10							

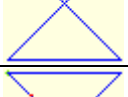
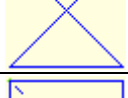
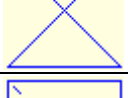
**9.4 List of Patterns for Doubling Controller**

NO.	Patterns	Stitch Number	Length × Width (mm)	NO.	Patterns	Stitch Number	Length × Width (mm)
1		41	16.1×2	2		41	10.2×2
3		41	16×2.4	4		41	24×3
5		27	10.1×2	6		27	16×2.4
7		35	10.1×2	8		35	16×2.4
9		55	24×3	10		63	24×3
11		20	6.1×2.4	12		27	6.2×2.4
13		35	6.1×2.4	14		14	8×2
15		20	8×2	16		27	8×2
17		20	10×0	18		27	10×0
19		27	25.2×0	20		35	24.8×0

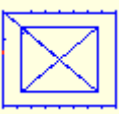
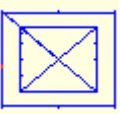
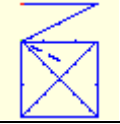
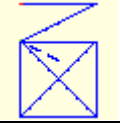
21		40	25.2×0	22		43	35×0
23		27	4×20	24		35	4×20
25		41	4×20	26		55	4×20
27		17	0×20	28		20	0×10
29		20	0×20	30		27	0×20
31		51	10.1×7	32		62	12.1×7
33		23	10.2×6	34		30	12×6
35		47	7×10	36		47	7×10
37		89	24×3	38		27	8×2
39		25	11.8×12	40		45	12×12
41		28	2.4×20	42		38	2.4×25
43		38	2.4×25	44		57	2.4×30
45		141	10×30	46		122	10×30
47		97	10×30	48		109	10.1×30

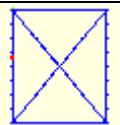
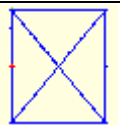
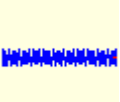
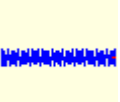
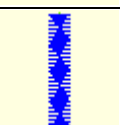
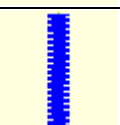
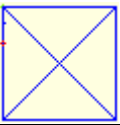
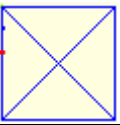
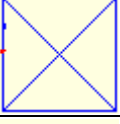
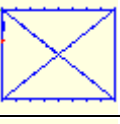
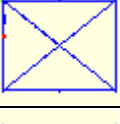
49		122	10.1×30	50		265	10×30
51		108	40×30	52		80	40×30
53		64	40×30	54		96	30×30
55		76	30×30	56		60	30×30
57		52	40×30	58		40	40×30
59		32	40×30	60		44	30×30
61		36	30×30	62		28	30×30
63		60	40×30	64		48	40×30
65		36	40×30	66		56	30×30
67		44	30×30	68		36	30×30
69		67	40×30	70		51	40×30
71		39	40×30	72		55	30×30
73		43	30×30	74		35	30×30
75		42	30×30	76		32	30.1×30

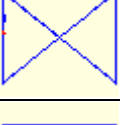
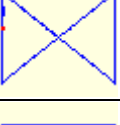
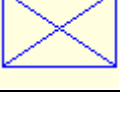
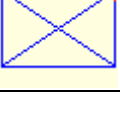
77		26	30×30	78		103	30×25
79		82	30×25	80		64	30×25
81		80	20×30	82		60	20×30
83		80	30×20	84		60	30×20
85		74	20×24	86		54	20×24
87		115	40×5	88		115	40×5
89		93	5×30	90		109	5×30
91		65	20×20	92		49	20×20
93		39	20×20	94		63	25×20
95		51	25×20	96		45	25×20
97		42	25×20	98		33	25×20
99		111	60×40	100		91	60×40

## 9.5 List of Warning

Code	Name	Release Method
E-001	Pedal is not at the middle position.	Check whether pedal is stepped at entering the Ready Sewing Interface
E-002	Machine is in emergency stop	Press to enter the Status of frame-moving at stop or press Reset Switch to trim thread and restart or return to origin.
E-003	Tilt of Machine Head Error	
E-004	Main voltage is too low (300V)	Please turn off the power and check the system hardware.
E-005	Main voltage is too high (300V)	
E-007	IPM over-voltage or over current	Please turn off the power and check the system hardware.
E-008	Voltage of assistant device (24V) is too high	Please turn off the power and check the system hardware.
E-009	Voltage of assistant device (24V) is too low	Please turn off the power and check the system hardware.
E-010	Valve (fan) problem	Please turn off the power and check the system hardware.
E-012	Presser Position Abnormal	Please turn off the power and check the system hardware.
E-013	Encoder error or unconnected	Please turn off the power and check the system hardware.
E-014	Motor running abnormal	Please turn off the power and check the system hardware.
E-015	Exceeds sewing area	Press Reset switch, and confirm the figure and X/Y scale rate. Activating Condition: Software Pattern Error
E-016	Needle bar upper position abnormal	Press The wrong stop position of main motor may be caused by the main shaft driver or the manual rotation. Turn the wheel to return the needle bar to the upper position.
E-017	Thread breakage detection error	Press
E-018	Knife position abnormal	Please turn off the power.
E-019	Emergency switch is not at the right position	Self-recovery
E-020	Stepping software version error	Please turn off the power.
E-021	Machine is in emergency stop (Free)	Press Reset
E-022	Machine is in emergency stop (Ready)	Press Reset
E-023	Thread-catching position error	Please turn off the power.
E-024	Wrong connection between operation panel and sewing machine	Please turn off the power.



E-025	X origin detection abnormal	Please turn off the power.
E-026	Y origin detection abnormal	Please turn off the power.
E-027	Presser origin detection abnormal	Please turn off the power.
E-028	Thread-catching origin detection abnormal	Please turn off the power.
E-029	Intermediate presser origin detection abnormal	Please turn off the power.
E-030	Stepping driver communication abnormal	Please turn off the power.
E-031	Stepping motor over-current	Please turn off the power.
E-032	Stepping driver power supply abnormal	Please turn off the power.
E-034	Abnormal current	Please turn off the power.
E-035	IPM frequent over-current 1	Please turn off the power.
E-036	IPM frequent over-current 2	Please turn off the power.
E-037	Motor blockage 1	Please turn off the power.
E-038	Motor blockage 2	Please turn off the power.
E-039	Motor over speed	Please turn off the power.
E-040	Stop over-current	Please turn off the power.
E-041	Motor overload	Please turn off the power.
E-042	Bus voltage abnormal	Please turn off the power.
E-043	Thread-trimming motor origin abnormal	Please turn off the power.
E-044	Head board EEPROM loading error	
E-045	Component abnormal	Please turn off the power.
E-046	CRC checking error	Please turn off the power.
E-047	Data checking error	Please turn off the power.
E-048	X checking error	Please turn off the power.
E-049	Y checking error	Please turn off the power.
E-050	MD1 stepping motor over-current	Please turn off the power.
E-051	MD1 X direction not finish	Please turn off the power.
E-052	MD1 Y direction not finish	Please turn off the power.
E-053	MD2 stepping motor over-current	Please turn off the power.
E-054	MD2 X direction not finish	Please turn off the power.
E-055	MD2 Y direction not finish	Please turn off the power.
E-056	Stepping close loop DSP1 communication error	Please turn off the power.
E-057	Stepping Close Loop DSP1 1st Route (X27) Over-current	Please turn off the power.
E-058	Stepping Close Loop DSP1 1st Route (X27) Position Error	Please turn off the power.
E-059	Stepping Close Loop DSP1 1st Route (X27) Over-speed	Please turn off the power.
E-060	Stepping Close Loop DSP1 2nd Route (X25) Over-current	Please turn off the power.
E-061	Stepping Close Loop DSP1 2nd Route (X25) Position Error	Please turn off the power.

E-062	Stepping Close Loop DSP1 2nd Route (X25) Over-speed	Please turn off the power.
E-063	Stepping Close Loop DSP2 communication error	Please turn off the power.
E-064	Stepping Close Loop DSP2 1st Route (X23) Over-current	Please turn off the power.
E-065	Stepping Close Loop DSP2 1st Route (X23) Position Error	Please turn off the power.
E-066	Stepping Close Loop DSP2 1st Route (X23) Over-speed	Please turn off the power.
E-067	Stepping Close Loop DSP2 2nd Route (X21) Over-current	Please turn off the power.
E-068	Stepping Close Loop DSP2 2nd Route (X21) Position Error	Please turn off the power.
E-069	Stepping Close Loop DSP2 2nd Route (X21) Over-speed	Please turn off the power.
E-070	Step drive board 90 power Over-current	Please turn off the power.
E-071	The lift head position is wrong	Please turn off the power.
E-072	Intermediate presser origin detection abnormal	Please turn off the power.
E-073	The XY needle is too wide spaced	Please turn off the power.
E-074 ~89	Stepping driver upgrade failure	
E-090	Query step state timeout	
E-091	Step Driver Version Error	
E-092	Stepping Driver Error	
E-093	Errors in Packet Checking of Step Closed-Loop DSP1 (X25/27) Communication	
E-094	Illegal Command of Data Packet in Step Closed-Loop DSP1 (X25/27) Communication	
E-095	Errors in Packet Checking of Step Closed-Loop DSP1 (X21/23) Communication	
E-096	Illegal Command of Data Packet in Step Closed-Loop DSP1 (X21/23) Communication	
E-097	The main control software does not match the hardware type of the main board	
E-098	CRC Checking Error of Step Drive DSP1 Curve	
E-099	CRC Checking Error of Step Drive DSP2	

	Curve	
E-100	System parameter version change, automatic initialization of all default system parameters	
E-101	Abnormal range of system parameters	
E-254	Undefined error	Undefined error

## 9.6 Hint List

No.	Name	Content
M-001	Can not find pattern data	Please reload or input from design software
M-002	Set value too large	Please input value within range
M-003	Set value too small	Please input value within range
M-004	Parameter save error	Press Enter to recover default setting
M-005	Communication error	Communication error between operation panel and control box
M-006	Fail to load letter sewing file	
M-007	Operation head not match to control box	Please check the model and the software version
M-008	Over Max stitch pitch	
M-009	Wrong password	Input again
M-010	Clock error	The hardware clock is down, please contact manufacturer for repair
M-011	Letter sewing pattern saved successfully	Enter the pattern selection interface and generate new letter sewing pattern
M-012	SRAM initialization	Clear all the data within SRAM, please turn off machine and restore the DIP switch
M-013	Turning off	
M-014	USB is pulled out	USB is pulled out
M-015	Can not find pattern in U disk	
M-016	At least input one letter	Periodical password has been set, can not change system time
M-017	No warning record	
M-018	Wrong user ID	Input again
M-019	Fail to confirm password	Input password again
M-020	Can not change system time	Periodical password has been set, can not change system time
M-021	Password file input error	
M-022	Password file load error	
M-023	Password save successful	
M-024	Clear all password failed	Can not delete password file
M-025	Fail to clear password	After clearance of password, the input of file has problem

M-026	Password file is deleted without authorization	Password file is deleted without authorization, please turn off machine
M-027	User ID file damaged	
M-028	Can not input blank	Input password again
M-029	Current password not match	Input current password again
M-030	New password not match	Input new password again
M-031	Enter touching panel correction mode	Are You Sure? Yes: enter No: X
M-032	Correction successful	Correction is successful, please restart machine
M-033	Correction failed	Please perform correction again
M-034	Clear warning record	Are You Sure? Yes: enter No: X
M-035	Periodical password is same to super password error	Input password again
M-036	Pattern data error	Current pattern data error, it will be replaced by default patterns
M-037	Pattern information file open failed	Restore to default pattern configuration
M-038	Memory full	Please delete the unused patterns
M-039	Cover the pattern	Are You Sure? Yes: enter No: X
M-040	P pattern open error	Pattern file has mistake, it will be deleted
M-041	C pattern open error	Pattern file has mistake, it will be deleted
M-042	Pattern is existed	Can not replace the pattern
M-043	Delete pattern data	Press Enter to delete; Press ESC to quit
M-044	Delete the selected pattern	Are You Sure? Yes: enter No: X
M-045	Pattern is used, can not delete	Please release the quotation at P or C pattern
M-046	Save at least one pattern	Can not delete last pattern
M-047	Load default patterns	No pattern in memory, please load default patterns
M-048	No pattern in memory	Press Enter to load default patterns
M-049	Pattern number not exist	Please input again
M-050	P pattern not exist	Please create P pattern
M-051	Save software version successful	Software version is saved to the root directory of U disk
M-052	Replace needle	Needle replacement set value is reached, please replace needle
M-053	Replace oil	Oil replacement set value is reached, please replace oil
M-054	Clean machine	Cleaning machine set value is reached, please clean machine
M-055	Clear needle replacement set value	Are You Sure? Yes: enter No: X
M-056	Clear oil replacement set value	Are You Sure? Yes: enter No: X
M-057	Clear cleaning time value	Are You Sure? Yes: enter No: X
M-058	Clear production control value	Are You Sure? Yes: enter No: X
M-059	Clear calculated running time	Are You Sure? Yes: enter No: X

M-060	Clear calculated sewing number?	Are You Sure? Yes: enter No: X
M-061	Clear calculated power-on time?	Are You Sure? Yes: enter No: X
M-062	Clear calculated sewing stitch number?	Are You Sure? Yes: enter No: X
M-063	Clear calculated over-current times?	Are You Sure? Yes: enter No: X
M-064	Clear calculated stop times?	Are You Sure? Yes: enter No: X
M-065	Edit new pattern?	Are You Sure? Yes: enter No: X
M-066	Return to sewing mode?	Are You Sure? Yes: enter No: X
M-067	Restore all the settings	Are You Sure? Yes: enter No: X
M-068	Restore the selected items	Are You Sure? Yes: enter No: X
M-069	Not select an item	Please select one or several parameters
M-070	Sewing counter reaches set value	Please pres Enter to clear it
M-071	No.of pcs counter reaches set value	Please pres Enter to clear it
M-072	Successful	Current operation is successful
M-073	Failed	Current operation is failed
M-074	Copy failed	Check the room of memory
M-075	Copy failed	Check whether the U disk is pulled out
M-076	File I/O error	File I/O error
M-077	Verification failed at updating main software	
M-078	Can not delete pattern data	The selected sewing data is in use
M-079	Perform parameter transfer	Are You Sure? Yes: enter No: X
M-080	Can not open changed pattern	Please confirm pattern file
M-081	Changed pattern format error	Please confirm pattern file
M-082	Changed pattern data is too long	Please confirm pattern file
M-083	Update successful	Update successful, please restart machine
M-084	Fail to open file	Fail to open file
M-085	Parameter restoration successful	Parameter restoration successful, please restart machine
M-086	Not select update item	Please select at least one item for update
M-087	Selected item for update is not existed	If the item has no update file, the system will cancel the selection. If user wants to update the rest, please confirm again
M-088	Initialize U disk	Press Enter to perform operation; Press ESC to quit. The initialization will delete all the files in U disk
M-089	Initialize memory	Press Enter to perform operation; Press ESC to quit. The initialization will delete all the files in memory
M-090	Low memory	
M-091	Fail to select the function	

M-092	Shape point repeated error	
M-093	Can not return	
M-094	Can not find next stitch sewing data	
M-095	Can not find previous stitch sewing data	
M-096	Pattern data is too big	
M-097	Calculation error	
M-098	Pattern-designing error	
M-099	Cannot find the pattern	
M-100	Over moving range	
M-101	Over sewing range	Make sure pattern within sewing range
M-102	Stitch number over range	Reduce stitch number
M-103	Pattern file error	
M-104	Confirm to change point	
M-105	Confirm to insert auto trimming code	
M-106	Delete new pattern?	Press Enter to confirm; Press ESC to quit
M-107	Delete elements?	Press Enter to confirm; Press ESC to quit
M-108	Confirm to perform?	Press Enter to confirm; Press ESC to quit
M-109	Delete mechanical control order?	Press Enter to confirm; Press ESC to quit
M-110	Delete needle entry point	Press Enter to confirm; Press ESC to quit
M-111	Are you sure to move presser?	Press Enter to confirm; Press ESC to quit
M-112	Delete shape point	Press Enter to confirm; Press ESC to quit
M-113	Warning: Initialization will delete entire data in memory!	Press Enter to confirm; Press ESC to quit
M-114	Change model?	Press Enter to confirm; Press ESC to quit
M-115	Pattern is locked	Please unlock first
M-116	Can not modify basic pattern	
M-117	Turn off machine.	Current operation is finished, please restart machine
M-118	Can not modify counter	At modification, please turn off setting
M-119	Load basic pattern	Press ENTER to load basic pattern, don't turn off machine!
M-120	Restore to default setting?	Press Enter to confirm; Press ESC to quit
M-121	Clear entire custom parameters?	Are You Sure? Yes: enter No: X
M-122	Head board parameter error	Press ENTER to restore to default values
M-123	Pattern calculation error	
M-124	Delete all the P and C patterns	Press Enter to confirm; Press ESC to quit
M-125	Restore head board parameters?	Are You Sure? Yes: enter No: X
M-126	Over setting range	
M-127	Can not find customized pattern	This operation is only available for customized pattern. The basic pattern can not be outputted!

M-128	Outer presser is at upper position	Please lower the presser to perform the operation!
M-129	Can not perform right operation	
M-130	Can not find USB	Please insert U disk containing mp3 file
M-131	No video files in vid.avi	Please put vid.avi file into pdat directory in U disk and then enter the update interface to update video files
M-132	Whether to switch the 1903 to reinforce the foundation pattern	After switching parameters, all patterns will be deleted and the underlying patterns are reloaded.
M-133	Scaling failure	Needle spacing beyond upper and lower limits
M-134	Failure of curve generation	Please input again
M-135	Arc or circle generation failure	Please input again
M-136	Parameter setting exception	The generated pattern data exceeds the maximum needle length. Please check the parameter settings.
M-137	Length or radius parameter setting exception	<ol style="list-style-type: none"> <li>1. The length of the bottom seam exceeds the length of the sleeve.</li> <li>2. Sleeve length is too long compared with bottom seam length.</li> <li>3. The inner diameter exceeds the outer diameter of the pattern.</li> <li>4. The height of half-month is lower than the distance of sleeve needle or the relative length of sleeve is too high.</li> <li>5. Check parameter settings</li> </ol>
M-138	Anomalies in needle spacing or number setting	Needle spacing is less than the minimum. Please check the needle spacing or needle number setting.
M-139	Sewing data exceeding maximum needle length	<ol style="list-style-type: none"> <li>1. Excessive distance between bottom stitches</li> <li>2. Too large spacing of zigzag stitches</li> <li>3. Please modify the parameter settings</li> </ol>
M-140	Master version is too low	
M-141	Basic pattern error, need to upgrade basic pattern	
M-142	Upgrade Step End Check Error	
M-143	Failure of two-dimensional code display	
M-144	Whether to determine recovery step parameters	Are You Sure? Yes: enter No: X